

RoHS Compliance

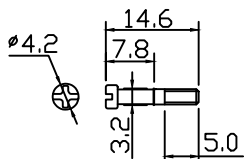

Short Screw

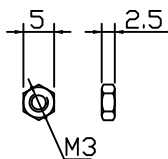
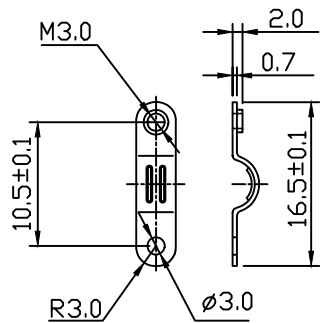
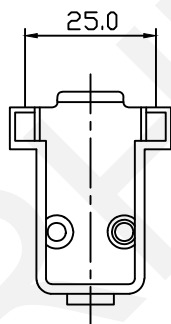
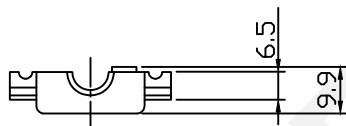
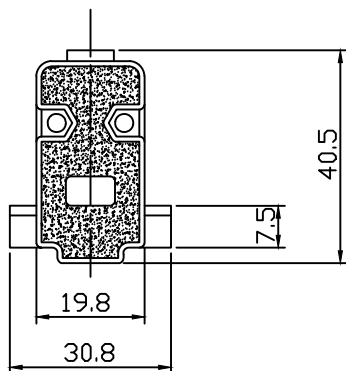

Cover Material: ABS Plastic
Screw Material: STEEL

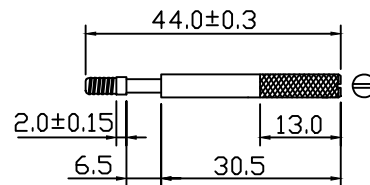
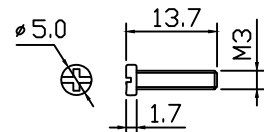
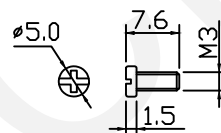
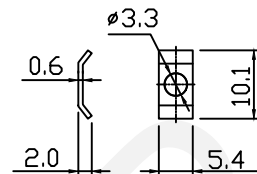

Long Screw

Order Information:
RHTAYB-09P-S-G

XXP-No.of
09,15,25,37,50pins
Screw:S-Short Screw
L-Long screw
Color: G-Gray B-Black

 NINGBO RHT ELECTRONIC CO.,LTD

| | | | | |
|----------|----------------|-------|-----------|---------------|
| UNITS:mm | SHEET SIZE: A4 | | SCALE:--- | DRWN BY PAN |
| 0~3 | 3~18 | 18~50 | 50~120 | CHK'D BY FENG |
| ±0.12 | ±0.15 | ±0.3 | ±0.5 | APPR BY ZHAN |

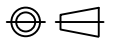
CONN DB HOOD PLASTIC ROHS
THIRD ANGLE PROJECTION
 RE-C-DB-09P-S-G

RoHS Compliance

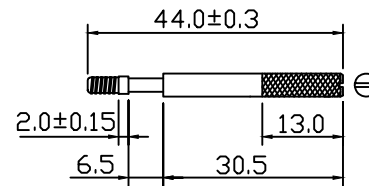
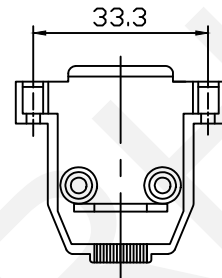
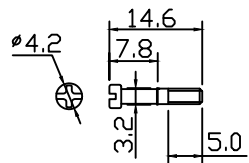
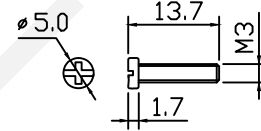
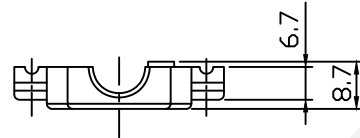
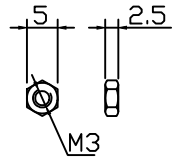
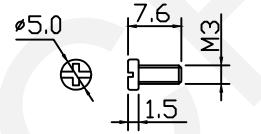
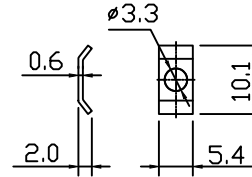
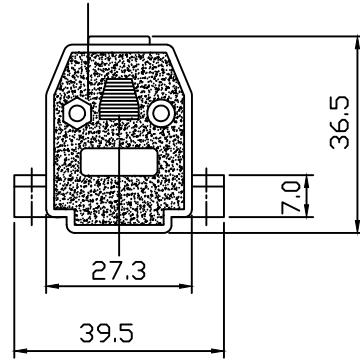
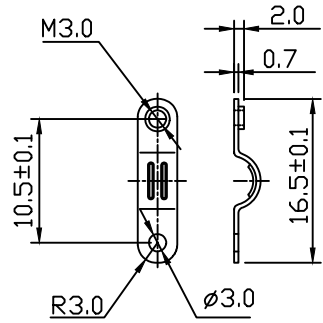

Order Information:

RHTAYB-15P-S-G

XXP-No.of

09,15,25,37,50pins

Screw:S-Short Screw

L-Long screw

Color: G-Gray B-Black

Short Screw

Cover Material: ABS Plastic
Screw Material: STEEL

Long Screw

 NINGBO RHT ELECTRONIC CO.,LTD

| | | | | |
|----------|----------------|-------|-----------|---------------|
| UNITS:mm | SHEET SIZE: A4 | | SCALE:--- | DRWN BY PAN |
| 0~3 | 3~18 | 18~50 | 50~120 | CHK'D BY FENG |
| ±0.12 | ±0.15 | ±0.3 | ±0.5 | APPR BY ZHAN |

CONN DB HOOD PLASTIC ROHS

THIRD ANGLE PROJECTION

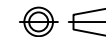

RE-C-DB-15P-S-G

RoHS Compliance

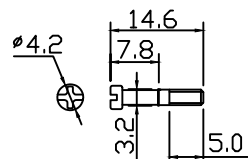
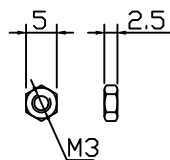
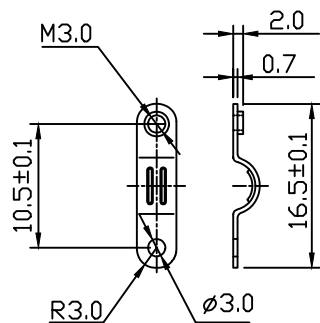

Short Screw

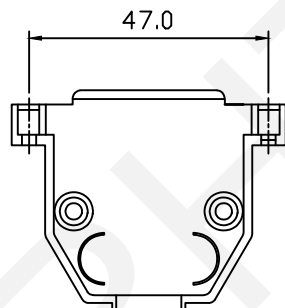
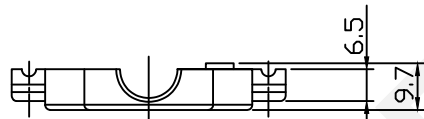
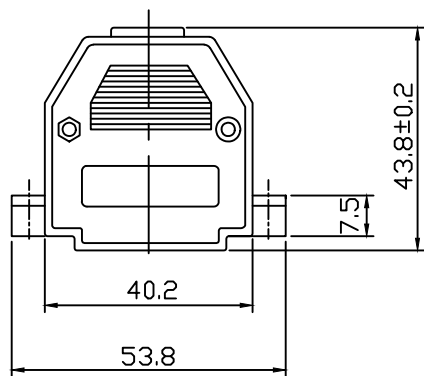

Cover Material: ABS Plastic
Screw Material: STEEL

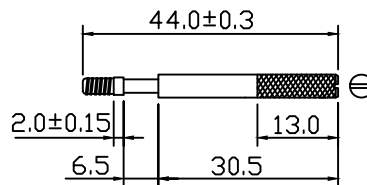
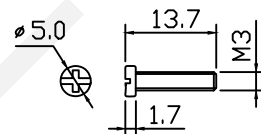
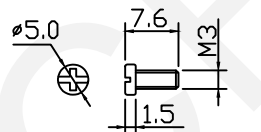
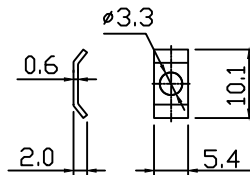

Long Screw

Order Information:
RHTAYB-25P-S-G

XXP-No.of
09,15,25,37,50pins
Screw:S-Short Screw
L-Long screw
Color: G-Gray B-Black

RHTECP NINGBO RHT ELECTRONIC CO.,LTD

| | | | |
|----------|----------------|-----------|-------------|
| UNITS:mm | SHEET SIZE: A4 | SCALE:--- | DRWN BY PAN |
| 0~3 | 3~18 | 18~50 | 50~120 |
| ±0.12 | ±0.15 | ±0.3 | ±0.5 |

| |
|---------------|
| CHK'D BY FENG |
| APPR BY ZHAN |

| | |
|---------------------------|-----------------|
| CONN DB HOOD PLASTIC ROHS | |
| THIRD ANGLE PROJECTION | RE-C-DB-25P-S-G |

RoHS Compliance

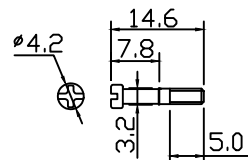
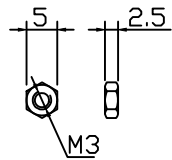
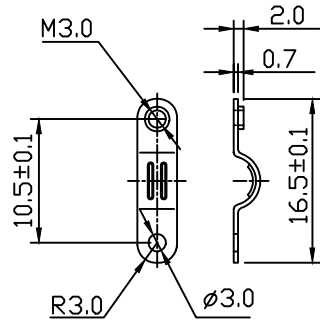

Short Screw

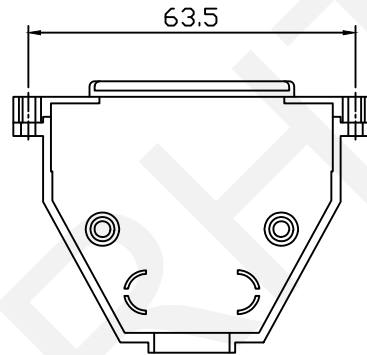
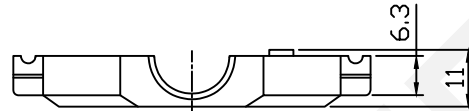
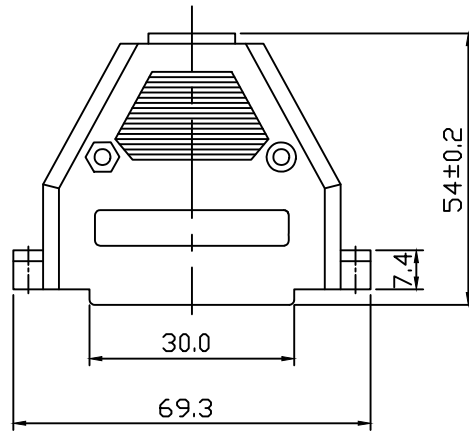

Cover Material: ABS Plastic
Screw Material: STEEL

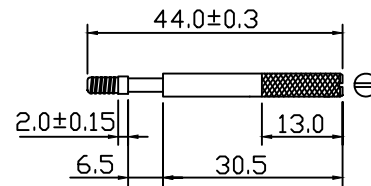
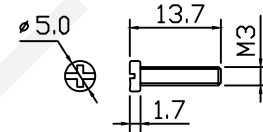
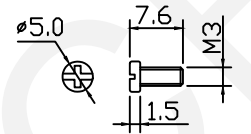
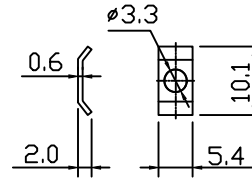

Long Screw

Order Information:

RHTAYB-37P-S-G

XXP-No.of

09,15,25,37,50pins

Screw:S-Short Screw

L-Long screw

Color: G-Gray B-Black

RHTECP NINGBO RHT ELECTRONIC CO.,LTD

| | | | |
|----------|----------------|-----------|-------------|
| UNITS:mm | SHEET SIZE: A4 | SCALE:--- | DRWN BY PAN |
| 0~3 | 3~18 | 18~50 | 50~120 |
| ±0.12 | ±0.15 | ±0.3 | ±0.5 |

CHK'D BY FENG
APPR BY ZHAN

CONN DB HOOD PLASTIC ROHS

THIRD ANGLE PROJECTION

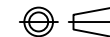

RE-C-DB-37P-S-G