

RoHS Compliance

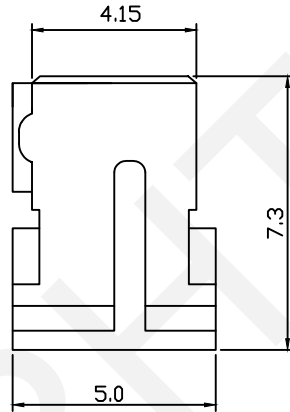
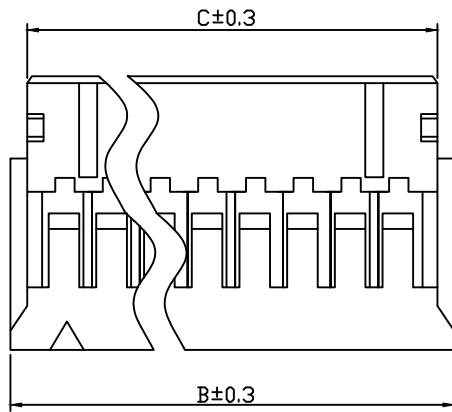
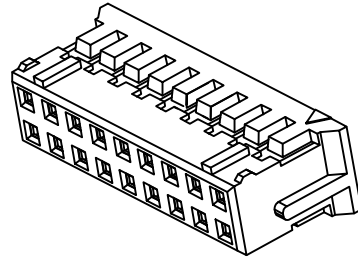
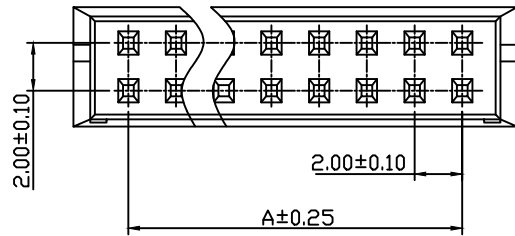

Pin	Dimension(mm)		
	A	B	C
2x02	2.00	6.00	4.40
2x03	4.00	8.00	6.40
2x04	6.00	10.00	8.40
2x05	8.00	12.00	10.40
2x06	10.00	14.00	12.40
2x07	12.00	16.00	14.40
2x08	14.00	18.00	16.40
2x09	16.00	20.00	18.40
2x10	18.00	22.00	20.40
2x11	20.00	24.00	22.40
2x12	22.00	26.00	24.40
2x13	24.00	28.00	26.40
2x14	26.00	30.00	28.40
2x15	28.00	32.00	30.40
2x16	30.00	34.00	32.40
2x17	32.00	36.00	34.40
2x18	34.00	38.00	36.40
2x19	36.00	40.00	38.40
2x20	38.00	42.00	40.40
2x21	40.00	44.00	42.40
2x22	42.00	46.00	44.40

Material:
Housing: PA66,UL94V-0

Electrical Characteristics:
Rated Current : 3.0AMP
Voltage Rating : 250V AC,DC
Temperature Range: -25°C~+85°C
Insulator Resistance: 1000MΩ/Min.
Withstanding Voltage: 800V AC/DC
Contact Resistance: 20MΩ/Max

Order Information:

RHTAYA1-2.00-XX-H

Pitch:2.00mm

XX-No.of 02~44Pins

Type:T-Terminal

H/H2/H3-Hosing

S/S2/S3-Straight Male Pin

R/R2/R3-Right Angle Male Pin

VM-Vertical SMT Pin

 NINGBO RHT ELECTRONIC CO.,LTD

UNITS:mm	SHEET SIZE: A4				SCALE:---	DRWN BY PAN
0~3	3~18	18~50	50~120	CHK'D BY FENG		
±0.12	±0.15	±0.3	±0.5	APPR BY ZHAN		

2.00mm Pitch PHD Type Double Wire To Board Connector

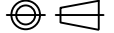
THIRD ANGLE PROJECTION 

RHTAYA1-2.00-XX-H

RoHS Compliance

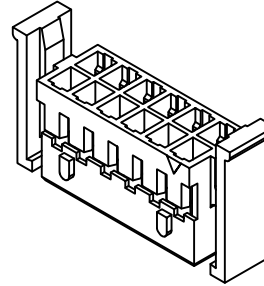
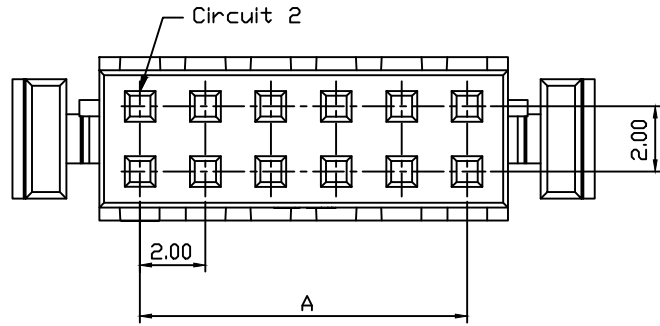

Pin	Dimension(mm)	
	A	B
2x02	2.00	4.50
2x03	4.00	6.50
2x04	6.00	8.50
2x05	8.00	10.50
2x06	10.00	12.50
2x07	12.00	14.50
2x08	14.00	16.50
2x09	16.00	18.50
2x10	18.00	20.50
2x11	20.00	22.50
2x12	22.00	24.50
2x13	24.00	26.50
2x14	26.00	28.50
2x15	28.00	30.50
2x16	30.00	32.50
2x17	32.00	34.50
2x18	34.00	36.50
2x19	36.00	38.50
2x20	38.00	40.50

Material:

Housing: PA66,UL94V-0,Color White

Electrical Characteristics:

Rated Current : 3.0AMP

Voltage Rating : 250V AC,DC

Temperature Range: -25°C~+85°C

Insulator Resistance: 1000MΩ/Min.

Withstanding Voltage: 800V AC/DC

Contact Resistance: 20MΩ/Max

Order Information:

RHTAYA1-2.00-XX-H2

Pitch:2.00mm

XX-No.of 02~40Pins

Type:T-Terminal

H/H2/H3-Hosing

S/S2/S3-Straight Male Pin

R/R2/R3-Right Angle Male Pin

VM-Vertical SMT Pin

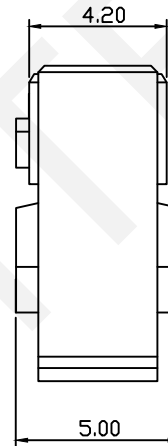
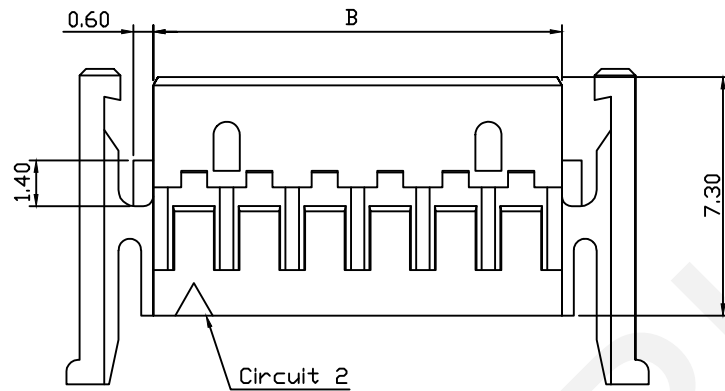

RHTECP NINGBO RHT ELECTRONIC CO.,LTD

UNITS:mm	SHEET SIZE: A4		SCALE:---	DRWN BY PAN
0~3	3~18	18~50	50~120	CHK'D BY FENG
±0.12	±0.15	±0.3	±0.5	APPR BY ZHAN

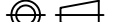
2.00mm Pitch PHD Type Double Wire To Board Connector
 THIRD ANGLE PROJECTION

 RHTAYA1-2.00-XX-H2

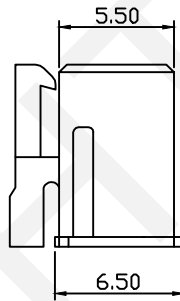
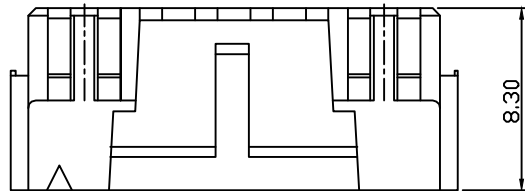
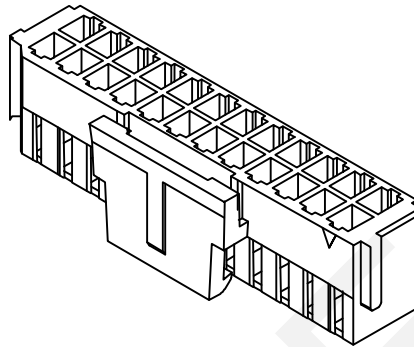
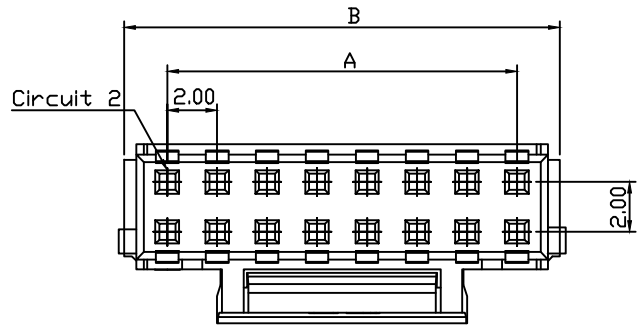
RoHS Compliance



Pin	Dimension(mm)	
	A	B
2x04	6.00	9.90
2x05	8.00	11.90
2x06	10.00	13.90
2x07	12.00	15.90
2x08	14.00	17.90
2x09	16.00	19.90
2x10	18.00	21.90
2x11	20.00	23.90
2x12	22.00	25.90
2x13	24.00	27.90
2x14	26.00	29.90
2x15	28.00	31.90
2x16	30.00	33.90
2x17	32.00	35.90
2x18	34.00	37.90
2x19	36.00	39.90
2x20	38.00	41.90

Material:

Housing: PA66,UL94V-0,Color:Natural

Electrical Characteristics:

Rated Current : 3.0AMP

Voltage Rating : 250V AC,DC

Temperature Range: -25°C~+85°C

Insulator Resistance: 1000MΩ/Min.

Withstanding Voltage: 800V AC/DC

Contact Resistance: 20MΩ/Max

Order Information:

RHTAYA1-2.00-XX-H3

Pitch:2.00mm

XX-No.of 08~40Pins

Type:T-Terminal

H/H2/H3-Hosing

S/S2/S3-Straight Male Pin

R/R2/R3-Right Angle Male Pin

VM-Vertical SMT Pin

 NINGBO RHT ELECTRONIC CO.,LTD

UNITS:mm	SHEET SIZE: A4			SCALE:----	DRWN BY PAN
0~3	3~18	18~50	50~120	CHK'D BY FENG	
±0.12	±0.15	±0.3	±0.5	APPR BY ZHAN	

2.00mm Pitch PHD Type Double Wire To Board Connector

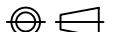
THIRD ANGLE PROJECTION 

RHTAYA1-2.00-XX-H3

RoHS Compliance

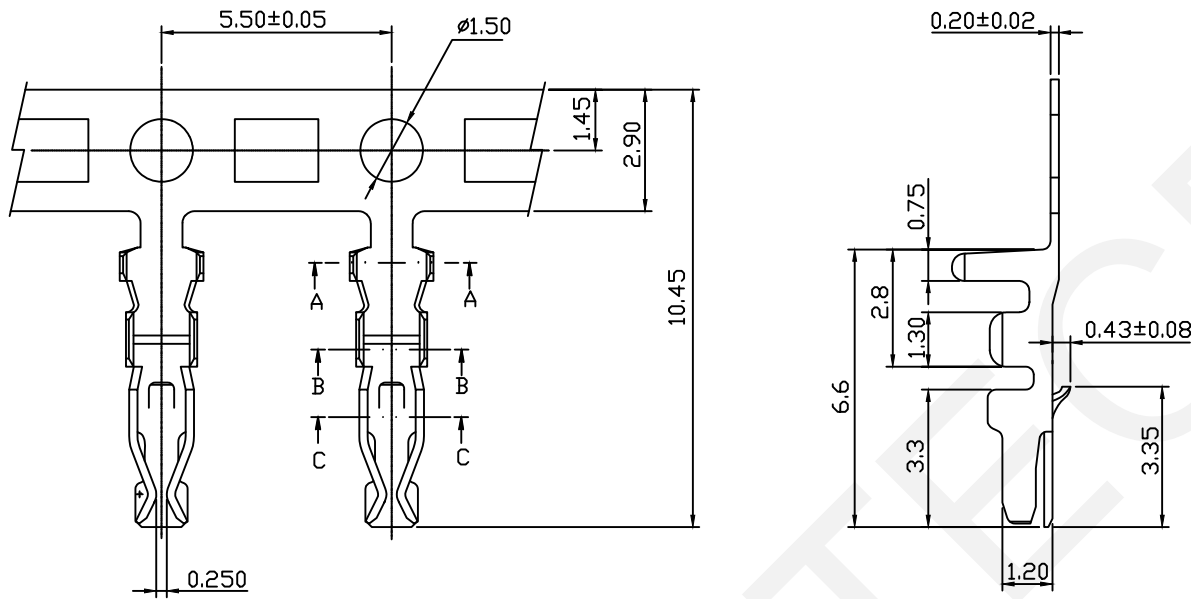

Material:
 Terminal: Phosphor Bronze
 Plating: Tin plated
 Applicable Wires: AWG #24~#28
 Insulation O.D: 0.90-1.40mm Max
 Qty/Reel: 10000 PCS

Electrical Characteristics:
 Rated Current : 3.0AMP
 Voltage Rating : 250V AC,DC
 Temperature Range: -25°C~+85°C
 Insulator Resistance: 1000MΩ/Min.
 Withstanding Voltage: 800V AC/Minute
 Contact Resistance: 20MΩ/Max

Order Information:

RHTAYA1-2.00-T

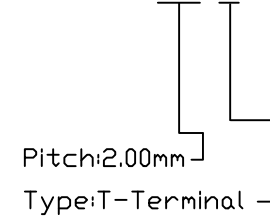

Pitch: 2.00mm
 Type: T-Terminal
 H/H2/H3-Hosing
 S/S2/S3-Straight Male Pin
 R/R2/R3-Right Angle Male Pin
 VM-Vertical SMT Pin

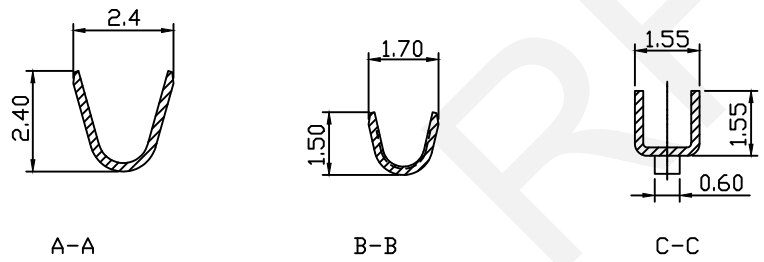

UNITS:mm	SHEET SIZE: A4			SCALE:---	DRWN BY PAN
0~3	3~18	18~50	50~120	CHK'D BY FENG	
±0.12	±0.15	±0.3	±0.5	APPR BY ZHAN	

2.00mm Pitch PHD Type Double Wire To Board Connector	
THIRD ANGLE PROJECTION	RHTAYA1-2.00-T

 NINGBO RHT ELECTRONIC CO.,LTD

RoHS Compliance

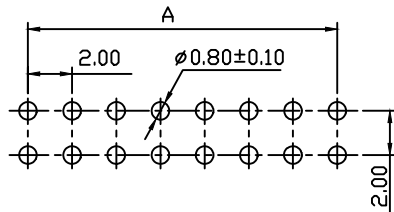
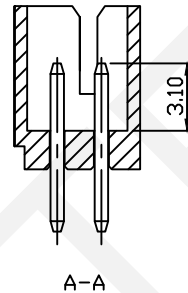
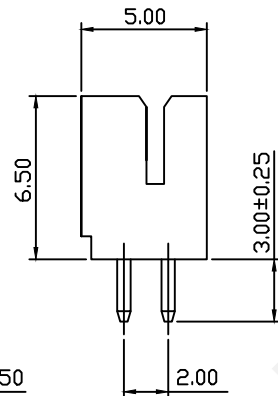
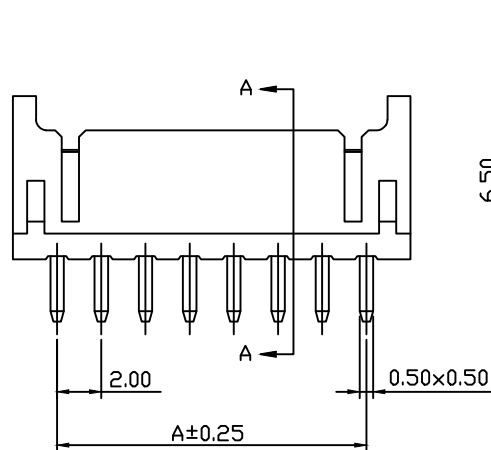
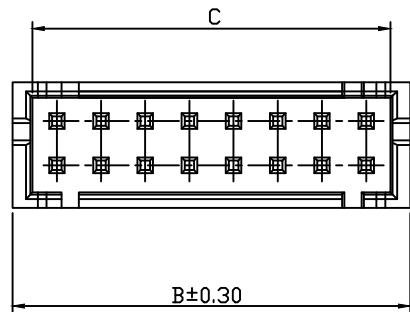

Recommended PCB Layout

Material:
Housing: PA66,UL94V-0
Contact:Brass
Plating: Tin Plated

Pin	Dimension(mm)		
	A	B	C
2x02	2.00	6.00	4.80
2x03	4.00	8.00	6.80
2x04	6.00	10.00	8.80
2x05	8.00	12.00	10.80
2x06	10.00	14.00	12.80
2x07	12.00	16.00	14.80
2x08	14.00	18.00	16.80
2x09	16.00	20.00	18.80
2x10	18.00	22.00	20.80
2x11	20.00	24.00	22.80
2x12	22.00	26.00	24.80
2x13	24.00	28.00	26.80
2x14	26.00	30.00	28.80
2x15	28.00	32.00	30.80
2x16	30.00	34.00	32.80
2x17	32.00	36.00	34.80
2x18	34.00	38.00	36.80
2x19	36.00	40.00	38.80
2x20	38.00	42.00	40.80

Electrical Characteristics:
Rated Current : 3.0AMP
Voltage Rating : 250V AC,DC
Temperature Range: -25°C~+85°C
Insulator Resistance: 1000MΩ/Min.
Withstanding Voltage: 800V AC/DC
Contact Resistance: 20MΩ/Max

Order Information:
RHTAYA1-2.00-XX-S

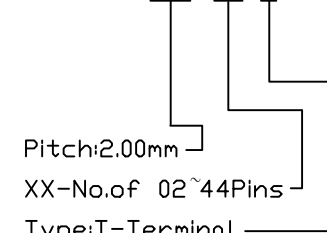

Pitch:2.00mm
XX-No.of 02~44Pins

Type:T-Terminal
H/H2/H3-Hosing
S/S2/S3-Straight Male Pin
R/R2/R3-Right Angle Male Pin
VM-Vertical SMT Pin

RHTECP NINGBO RHT ELECTRONIC CO.,LTD

UNITS:mm	SHEET SIZE: A4			SCALE:---	DRWN BY PAN
0~3	3~18	18~50	50~120	CHK'D BY FENG	
±0.12	±0.15	±0.3	±0.5	APPR BY ZHAN	

2.00mm Pitch PHD Type Double Wire To Board Connector
THIRD ANGLE PROJECTION
 RHTAYA1-2.00-XX-S

RoHS Compliance

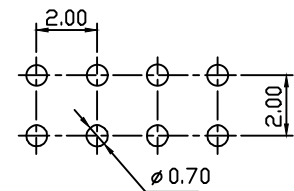
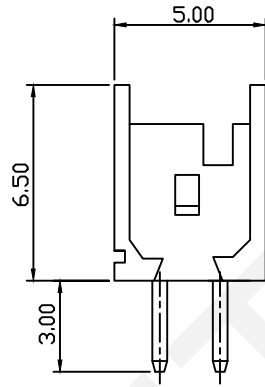
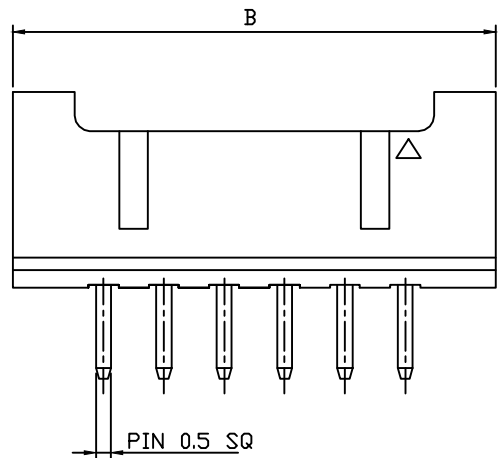
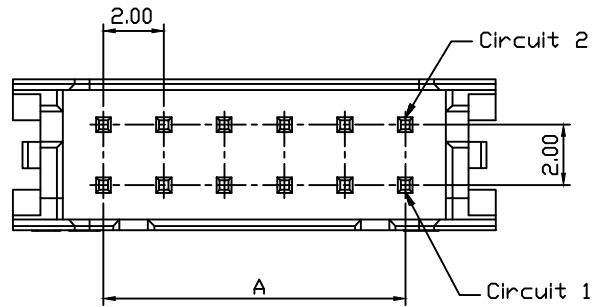

Recommended PCB Layout

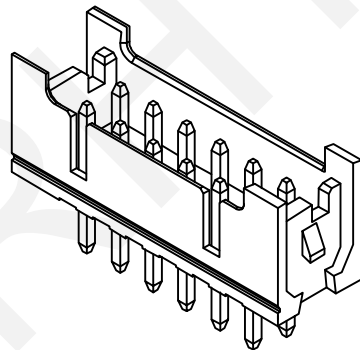

Pin	Dimension(mm)	
	A	B
2x02	2.00	8.00
2x03	4.00	10.00
2x04	6.00	12.00
2x05	8.00	14.00
2x06	10.00	16.00
2x07	12.00	18.00
2x08	14.00	20.00
2x09	16.00	22.00
2x10	18.00	24.00
2x11	20.00	26.00
2x12	22.00	28.00
2x13	24.00	30.00
2x14	26.00	32.00
2x15	28.00	34.00
2x16	30.00	36.00
2x17	32.00	38.00
2x18	34.00	40.00
2x19	36.00	42.00
2x20	38.00	44.00

Material:
Housing: PA66,UL94V-0
Contact:Brass
Plating: Tin Plated

Electrical Characteristics:
Rated Current : 3.0AMP
Voltage Rating : 250V AC,DC
Temperature Range: -25°C~+85°C
Insulator Resistance: 1000MΩ/Min.
Withstanding Voltage: 800V AC/DC
Contact Resistance: 20MΩ/Max

Order Information:
RHTAYA1-2.00-XX-S2

Pitch:2.00mm
XX-No.of 02~40Pins
Type:T-Terminal
H/H2/H3-Hosing
S/S2/S3-Straight Male Pin
R/R2/R3-Right Angle Male Pin
VM-Vertical SMT Pin

RHTECP NINGBO RHT ELECTRONIC CO.,LTD

UNITS:mm	SHEET SIZE: A4	SCALE:---	DRWN BY PAN
0~3	3~18	18~50	50~120
±0.12	±0.15	±0.3	±0.5
			CHK'D BY FENG
			APPR BY ZHAN

2.00mm Pitch PHD Type Double Wire To Board Connector
THIRD ANGLE PROJECTION
 RHTAYA1-2.00-XX-S2

RoHS Compliance

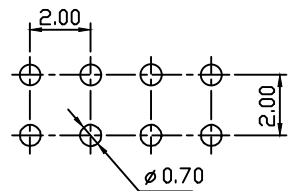
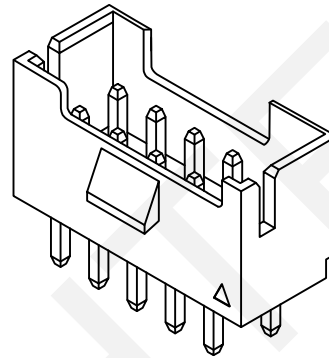
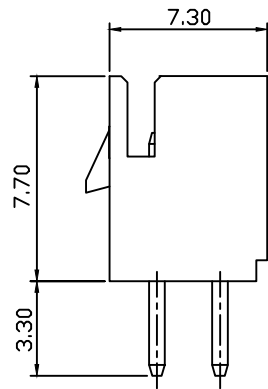
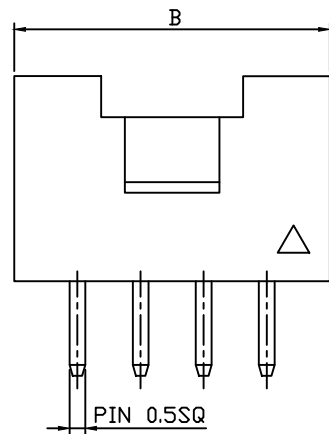
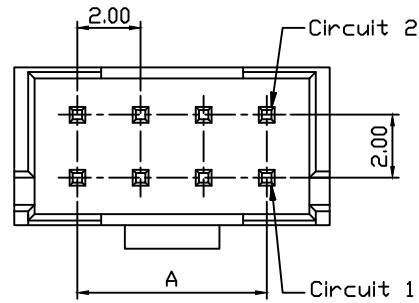

Recommended PCB Layout

Pin	Dimension(mm)	
	A	B
2x02	2.00	6.00
2x03	4.00	8.00
2x04	6.00	10.00
2x05	8.00	12.00
2x06	10.00	14.00
2x07	12.00	16.00
2x08	14.00	18.00
2x09	16.00	20.00
2x10	18.00	22.00
2x11	20.00	24.00
2x12	22.00	26.00
2x13	24.00	28.00
2x14	26.00	30.00
2x15	28.00	32.00
2x16	30.00	34.00
2x17	32.00	36.00
2x18	34.00	38.00
2x19	36.00	40.00
2x20	38.00	42.00

Material:
Housing: PA46,UL94V-0
Contact:Brass
Plating: Tin Plated

Electrical Characteristics:
Rated Current : 3.0AMP
Voltage Rating : 250V AC,DC
Temperature Range: -25°C~+85°C
Insulator Resistance: 1000MΩ/Min.
Withstanding Voltage: 800V AC/DC
Contact Resistance: 20MΩ/Max

Order Information:
RHTAYA1-2.00-XX-S3

Pitch:2.00mm
XX-No.of 08~40Pins
Type:T-Terminal
H/H2/H3-Hosing
S/S2/S3-Straight Male Pin
R/R2/R3-Right Angle Male Pin
VM-Vertical SMT Pin

NINGBO RHT ELECTRONIC CO.,LTD

UNITS:mm	SHEET SIZE: A4			SCALE:---	DRWN BY PAN
0~3	3~18	18~50	50~120	CHK'D BY FENG	
±0.12	±0.15	±0.3	±0.5	APPR BY ZHAN	

2.00mm Pitch PHD Type Double Wire To Board Connector
THIRD ANGLE PROJECTION
 RHTAYA1-2.00-XX-S3

RoHS Compliance

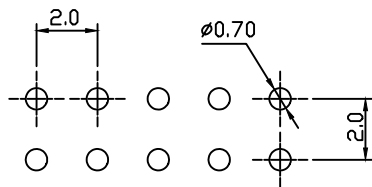
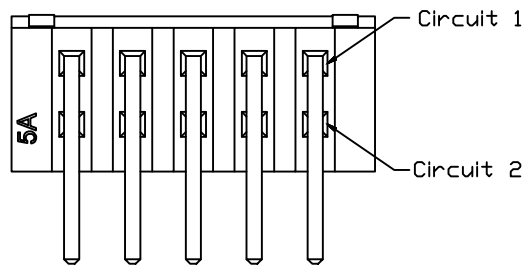
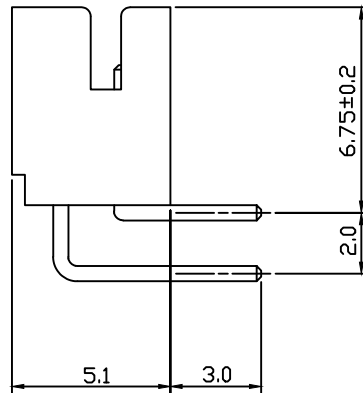
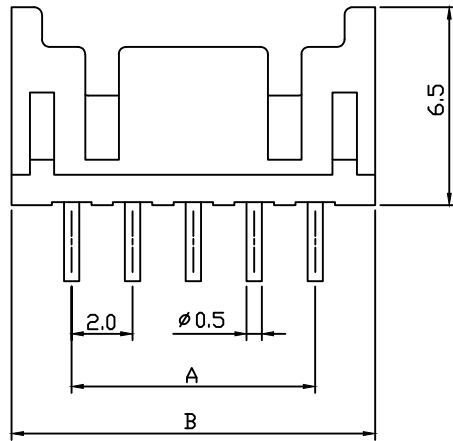

Recommended PCB Layout

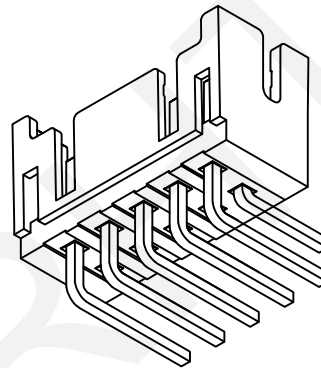

Pin	Dimension(mm)	
	A	B
2x02	2.00	6.00
2x03	4.00	8.00
2x04	6.00	10.00
2x05	8.00	12.00
2x06	10.00	14.00
2x07	12.00	16.00
2x08	14.00	18.00
2x09	16.00	20.00
2x10	18.00	22.00
2x11	20.00	24.00
2x12	22.00	26.00
2x13	24.00	28.00
2x14	26.00	30.00
2x15	28.00	32.00
2x16	30.00	34.00
2x17	32.00	36.00
2x18	34.00	38.00
2x19	36.00	40.00
2x20	38.00	42.00

Material:
Housing: PA66,UL94V-0
Contact:Brass
Plating: Tin Plated

Electrical Characteristics:
Rated Current : 3.0AMP
Voltage Rating : 250V AC,DC
Temperature Range: -25°C~+85°C
Insulator Resistance: 1000MΩ/Min.
Withstanding Voltage: 800V AC/DC
Contact Resistance: 10MΩ/Max

Order Information:
RHTAYA1-2.00-XX-R

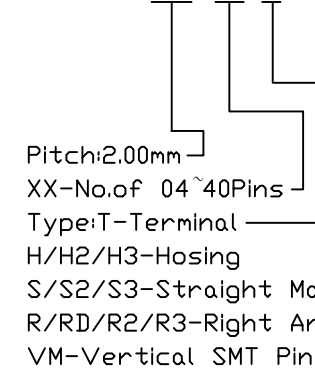

Pitch:2.00mm
XX-No.of 04~40Pins
Type:T-Terminal
H/H2/H3-Hosing
S/S2/S3-Straight Male Pin
R/RD/R2/R3-Right Angle Male Pin
VM-Vertical SMT Pin

RHTECP NINGBO RHT ELECTRONIC CO.,LTD

UNITS:mm	SHEET SIZE: A4	SCALE:---	DRWN BY PAN
0~3	3~18	18~50	50~120
±0.12	±0.15	±0.3	±0.5
			CHK'D BY FENG
			APPR BY ZHAN

2.00mm Pitch PHD Type Double Wire To Board Connector
THIRD ANGLE PROJECTION
 RHTAYA1-2.00-XX-R

RoHS Compliance

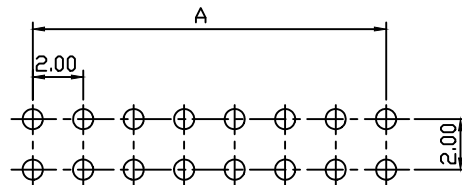
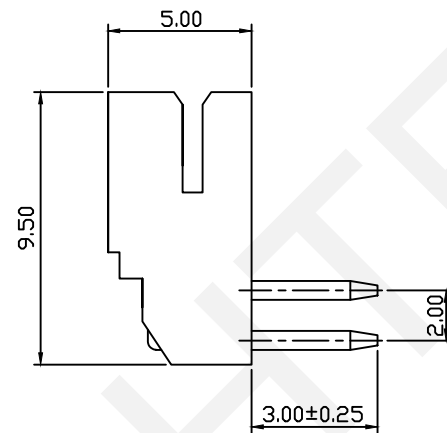
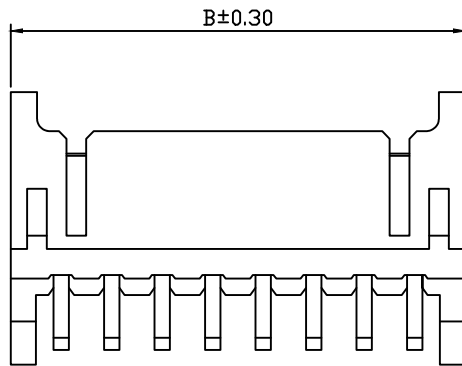
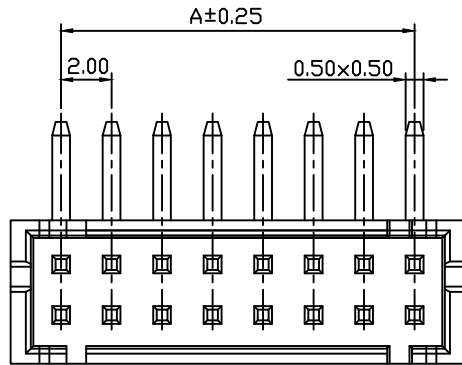

Recommended PCB Layout

Material:
Housing: PA66,UL94V-0
Contact:Brass
Plating: Tin Plated

Electrical Characteristics:
Rated Current : 3.0AMP
Voltage Rating : 250V AC,DC
Temperature Range: -25°C~+85°C
Insulator Resistance: 1000MΩ/Min.
Withstanding Voltage: 800V AC/DC
Contact Resistance: 20MΩ/Max

Order Information:
RHTAYA1-2.00-XX-RD

Pitch:2.00mm
XX-No.of 02~44Pins
Type:T-Terminal
H/H2/H3-Hosing
S/S2/S3-Straight Male Pin
R/RD/R2/R3-Right Angle Male Pin
VM-Vertical SMT Pin

Pin	Dimension(mm)	
	A	B
2x02	2.00	6.00
2x03	4.00	8.00
2x04	6.00	10.00
2x05	8.00	12.00
2x06	10.00	14.00
2x07	12.00	16.00
2x08	14.00	18.00
2x09	16.00	20.00
2x10	18.00	22.00
2x11	20.00	24.00
2x12	22.00	26.00
2x13	24.00	28.00
2x14	26.00	30.00
2x15	28.00	32.00
2x16	30.00	34.00
2x17	32.00	36.00
2x18	34.00	38.00
2x19	36.00	40.00
2x20	38.00	42.00

NINGBO RHT ELECTRONIC CO.,LTD

UNITS:mm	SHEET SIZE: A4				SCALE:---	DRWN BY PAN
0~3	3~18	18~50	50~120	CHK'D BY FENG	2.00mm Pitch PHD Type Double Wire To Board Connector	
±0.12	±0.15	±0.3	±0.5	APPR BY ZHAN	THIRD ANGLE PROJECTION	RHTAYA1-2.00-XX-RD

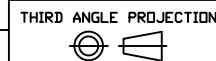

RoHS Compliance

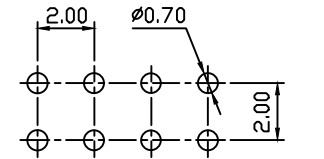
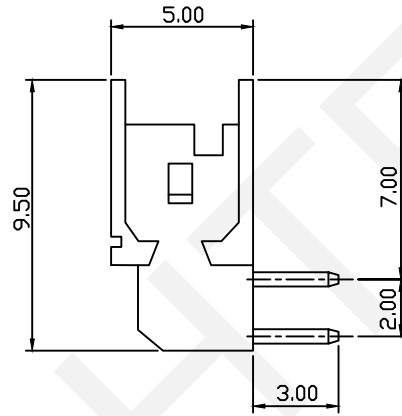
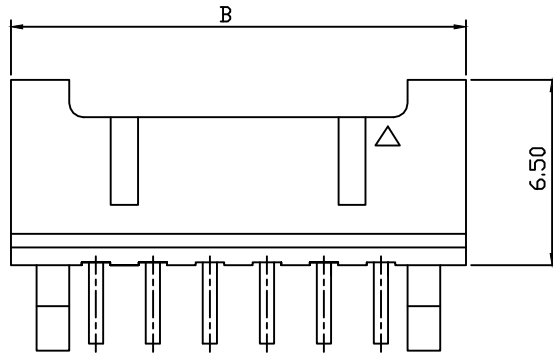
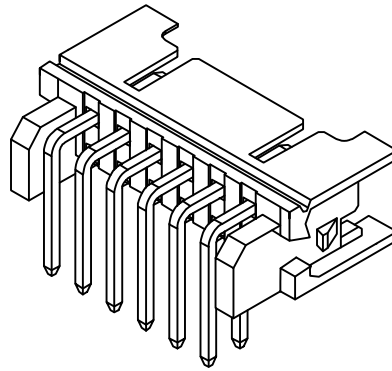
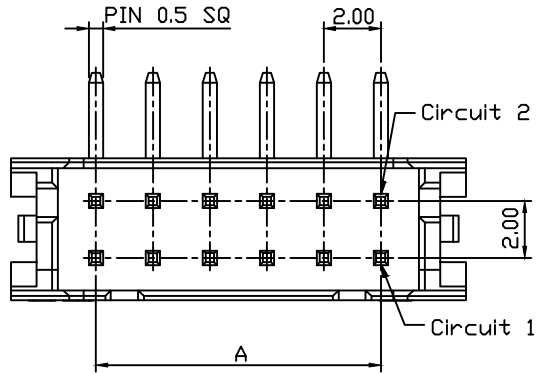

Recommended PCB Layout

Pin	Dimension(mm)	
	A	B
2x02	2.00	8.00
2x03	4.00	10.00
2x04	6.00	12.00
2x05	8.00	14.00
2x06	10.00	16.00
2x07	12.00	18.00
2x08	14.00	20.00
2x09	16.00	22.00
2x10	18.00	24.00
2x11	20.00	26.00
2x12	22.00	28.00
2x13	24.00	30.00
2x14	26.00	32.00
2x15	28.00	34.00
2x16	30.00	36.00
2x17	32.00	38.00
2x18	34.00	40.00
2x19	36.00	42.00
2x20	38.00	44.00

Material:
Housing: PA9T,UL94V-0
Contact:Brass
Plating: Tin Plated

Electrical Characteristics:
Rated Current : 3.0AMP
Voltage Rating : 250V AC,DC
Temperature Range: -25°C~+85°C
Insulator Resistance: 1000MΩ/Min.
Withstanding Voltage: 800V AC/DC
Contact Resistance: 20MΩ/Max

Order Information:
RHTAYA1-2.00-XX-R2

Pitch:2.00mm
XX-No.of 02~40Pins
Type:T-Terminal
H/H2/H3-Hosing
S/S2/S3-Straight Male Pin
R/RD/R2/R3-Right Angle Male Pin
VM-Vertical SMT Pin

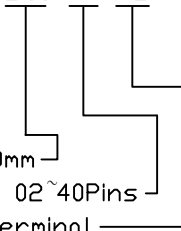

RHTECP NINGBO RHT ELECTRONIC CO.,LTD

UNITS:mm	SHEET SIZE: A4			SCALE:---	DRWN BY PAN
0~3	3~18	18~50	50~120	CHK'D BY FENG	
±0.12	±0.15	±0.3	±0.5	APPR BY ZHAN	

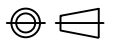
2.00mm Pitch PHD Type Double Wire To Board Connector
THIRD ANGLE PROJECTION

RHTAYA1-2.00-XX-R2

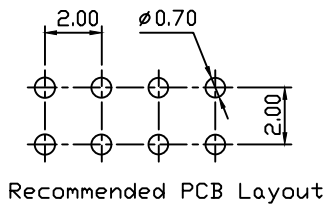
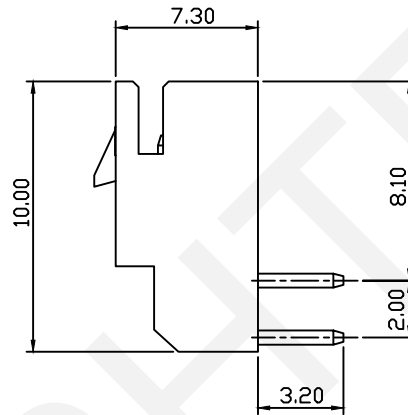
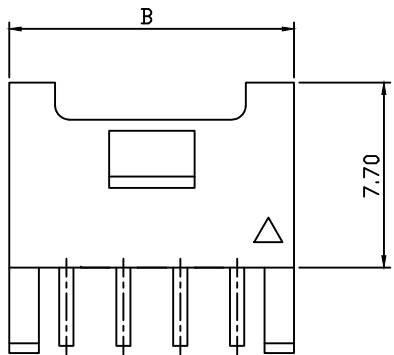
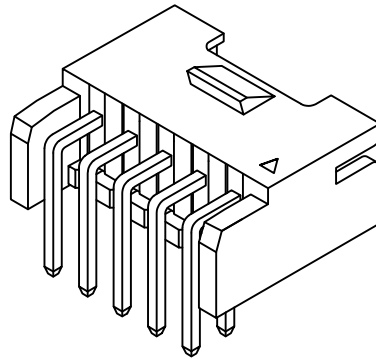
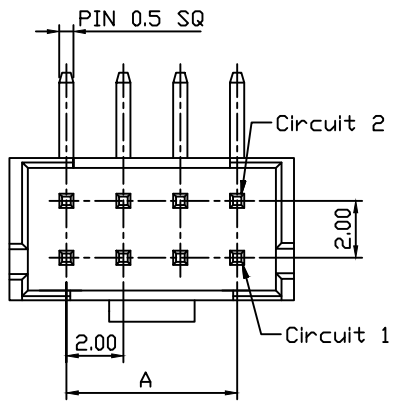
RoHS Compliance



Pin	Dimension(mm)	
	A	B
2x02	2.00	6.00
2x03	4.00	8.00
2x04	6.00	10.00
2x05	8.00	12.00
2x06	10.00	14.00
2x07	12.00	16.00
2x08	14.00	18.00
2x09	16.00	20.00
2x10	18.00	22.00
2x11	20.00	24.00
2x12	22.00	26.00
2x13	24.00	28.00
2x14	26.00	30.00
2x15	28.00	32.00
2x16	30.00	34.00
2x17	32.00	36.00
2x18	34.00	38.00
2x19	36.00	40.00
2x20	38.00	42.00

Material:
Housing: PA46,UL94V-0
Contact:Brass
Plating: Tin Plated

Electrical Characteristics:
Rated Current : 3.0AMP
Voltage Rating : 250V AC,DC
Temperature Range: -25°C~+85°C
Insulator Resistance: 1000MΩ/Min.
Withstanding Voltage: 800V AC/DC
Contact Resistance: 20MΩ/Max

Order Information:
RHTAYA1-2.00-XX-R3

Pitch:2.00mm
XX-No.of 08~40Pins
Type:T-Terminal
H/H2/H3-Hosing
S/S2/S3-Straight Male Pin
R/RD/R2/R3-Right Angle Male Pin
VM-Vertical SMT Pin

NINGBO RHT ELECTRONIC CO.,LTD

UNITS:mm	SHEET SIZE: A4		SCALE:---	DRWN BY PAN
0~3	3~18	18~50	50~120	CHK'D BY FENG
±0.12	±0.15	±0.3	±0.5	APPR BY ZHAN

2.00mm Pitch PHD Type Double Wire To Board Connector
 RHTAYA1-2.00-XX-R3

RoHS Compliance

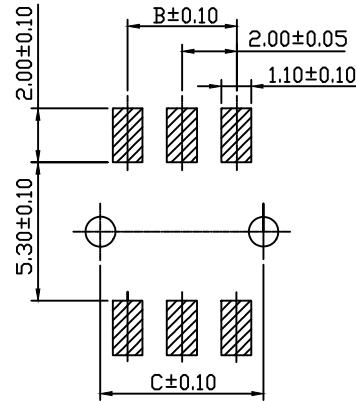
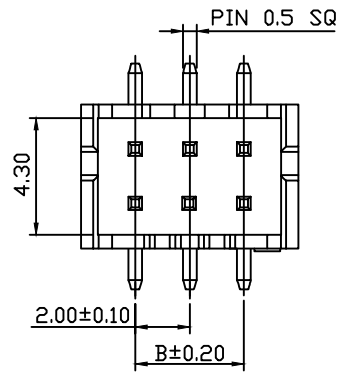

Recommended PCB Layout

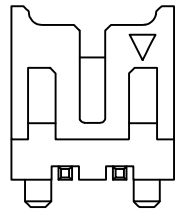
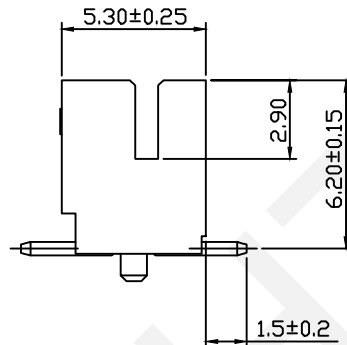
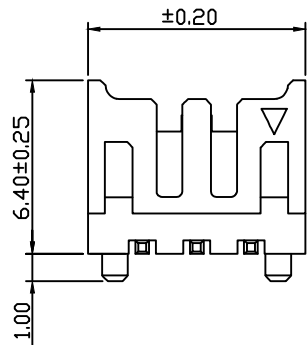

02P

Material:
Housing: PA9T,UL94V-0
Contact:Brass
Plating: Tin Plated

Electrical Characteristics:
Rated Current : 3.0AMP
Voltage Rating : 250V AC,DC
Temperature Range: -25°C~+85°C
Insulator Resistance: 1000MΩ/Min.
Withstanding Voltage: 800V AC/DC
Contact Resistance: 20MΩ/Max

Order Information:
RHTAYA1-2.00-XX-VM

Pitch:2.00mm
XX-No.of 02~40Pins
Type:T-Terminal
H/H2/H3-Hosing
S/S2/S3-Straight Male Pin
R/R2/R3-Right Angle Male Pin
VM-Vertical SMT Pin

Pin	Dimension(mm)		
	A	B	C
2x02	6.00	2.00	6.00
2x03	8.00	4.00	8.00
2x04	10.00	6.00	10.00
2x05	12.00	8.00	12.00
2x06	14.00	10.00	14.00
2x07	16.00	12.00	16.00
2x08	18.00	14.00	18.00
2x09	20.00	16.00	20.00
2x10	22.00	18.00	22.00
2x11	24.00	20.00	24.00
2x12	26.00	22.00	26.00
2x13	28.00	24.00	28.00
2x14	30.00	26.00	30.00
2x15	32.00	28.00	32.00
2x16	34.00	30.00	34.00
2x17	36.00	32.00	36.00
2x18	38.00	34.00	38.00
2x19	40.00	36.00	40.00
2x20	42.00	38.00	42.00

RHTECP NINGBO RHT ELECTRONIC CO.,LTD

UNITS:mm SHEET SIZE: A4 SCALE:--- DRWN BY PAN
0~3 3~18 18~50 50~120 CHK'D BY FENG
±0.12 ±0.15 ±0.3 ±0.5 APPR BY ZHAN

2.00mm Pitch PHD Type Double Wire To Board Connector
THIRD ANGLE PROJECTION
RHTAYA1-2.00-XX-VM