

Recommended P.C.B Layout(Top Side)
(PCB BOARD TOLERANCE±0.05)

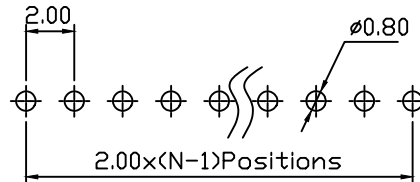

Material:
Standard: PA6T
Contact: Brass
Insulator: Polyester,UL94V-0
Electrical Characteristics:
Rated Current: 1.5AMP
Contact Resistance: 20mΩ Max
Withstand Voltage: 500V AC/DC
Insulator Resistance: 1000MΩ Min
Mechanical
Operating Temperature: -40°C~+105°C
Max.Processing Temp:240°C for 30-60 seconds
(260°C for 10 seconds)

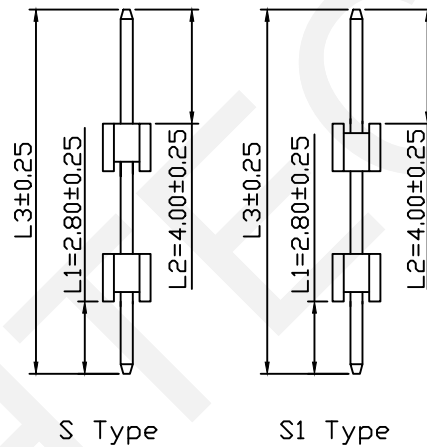
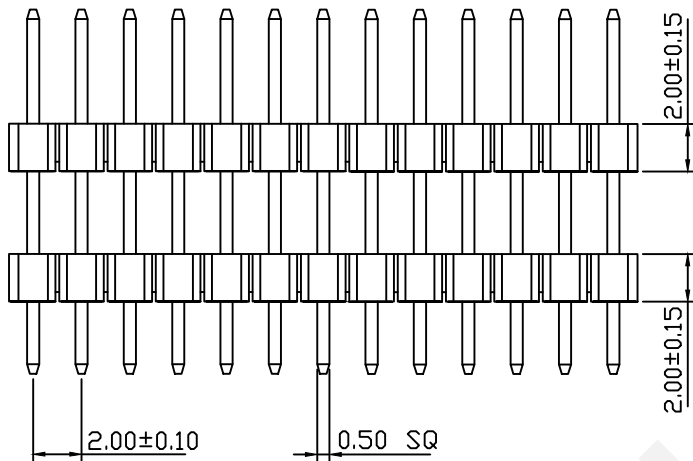

Order Information:
RHTAY18B-2.00-1-XX-S-L1xL2xL3-G0

Pin Header Series
18B: 2.00mm
Plastics Height: 1.50, 2.00 mm
Per Row:Single Layer
Pin: No. of Pins (1x40)
Straight Pin:S Type, S1 Type
Size:L1xL2xL3
Plating:
G0=Gold Flash G1=1u" Gold
G10=10u" Gold G15=15u" Gold
G30=30u" Gold

Dimension Antitheses List (mm)				
ITEM	L1	L2	L3	Plastic Height
Standard	2.80	4.00	---	2.00
Nonstandard	---	---	---	---

UNITS:mm	SHEET SIZE: A4	SCALE:---	DRWN BY PAN
0~3	3~18	18~50	50~120
±0.12	±0.15	±0.3	±0.5
CHK'D BY FENG		APPR BY ZHAN	

2.00mm Pin Header Single Layer,Straight Pin, 1xN Pin	
THIRD ANGLE PROJECTION 	RHTAY18B-2.00-1-XX-S-L1xL2xL3-G0



NINGBO RHT ELECTRONIC CO.,LTD

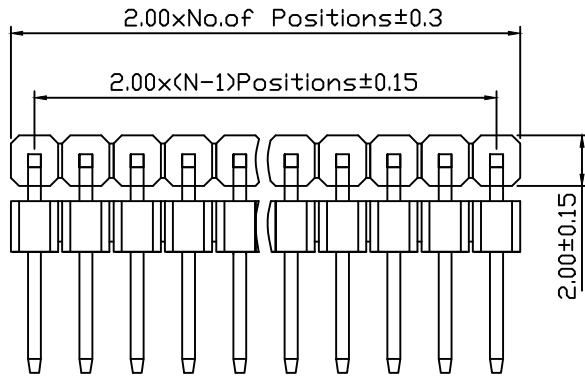

Recommended P.C.Board Layout
PCB Tolerance±0.05(Top View)

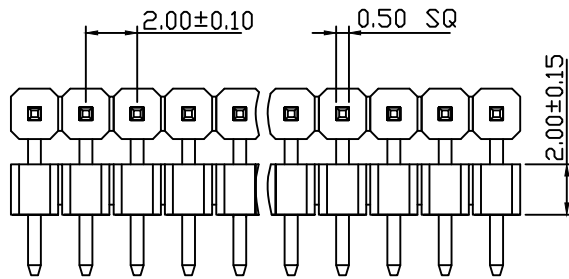
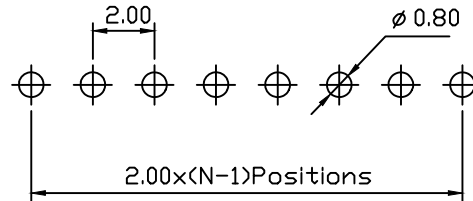

Dimension Antitheses List (mm)						
ITEM	L1	L2	D	D1	D2	Plastic Height
Standard	2.80	4.00	---	---	---	2.00
Nonstandard	---	---	---	---	---	---

Material:
Standard: PA6T
Contact: Brass
Insulator: Polyester,UL94V-0
Electrical Characteristics:
Rated Current: 1.5AMP
Contact Resistance: 20mΩ Max
Withstand Voltage: 500V AC/DC
Insulator Resistance: 1000MΩ Min
Mechanical
Operating Temperature: -40°C~+105°C
Max.Processing Temp:240°C for 30-60 seconds
(260°C for 10 seconds)

Order Information:
RHTAY18B-2.00-1-XX-R2-L1xL2xD-G0

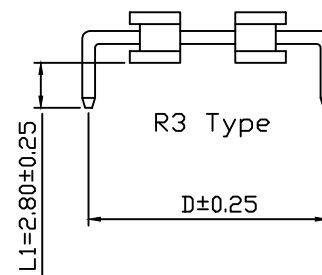
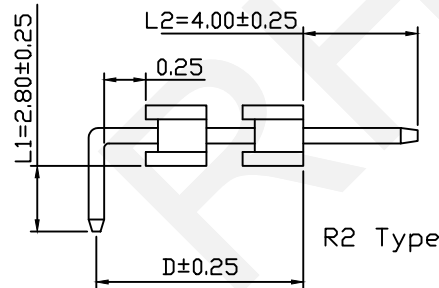
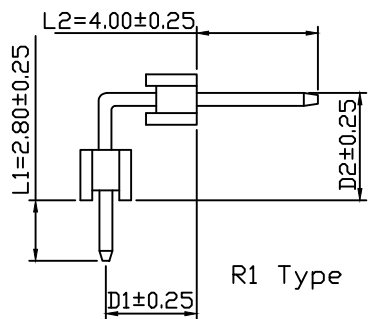
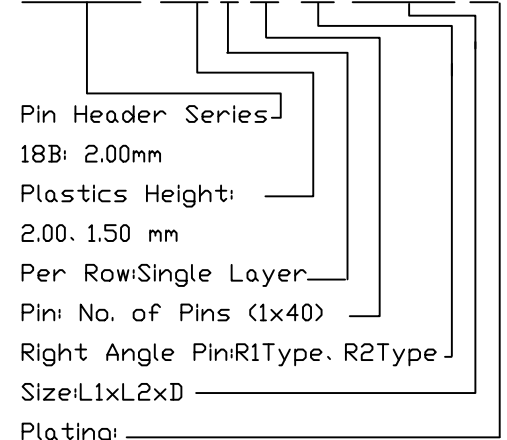

Plating:
G0=Gold Flash G1=1u" Gold
G10=10u" Gold G15=15u" Gold
G30=30u" Gold

RHTECP NINGBO RHT ELECTRONIC CO.,LTD

UNITS:mm	SHEET SIZE: A4	SCALE:---	DRWN BY PAN
0~3	3~18	18~50	50~120
±0.12	±0.15	±0.3	±0.5
CHK'D BY FENG		APPR BY ZHAN	

2.00mm Pin Header
Single Layer,Right Angle Pin, 1xN Pin
THIRD ANGLE PROJECTION
RHTAY18B-2.00-1-XX-R2-L1xL2xD-G0

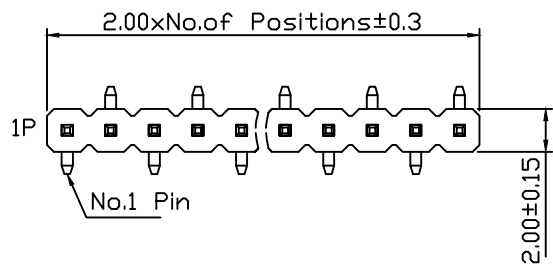

Recommended P.C.B Layout(Top Side)
(PCB BOARD TOLERANCE±0.05)

T2 Type

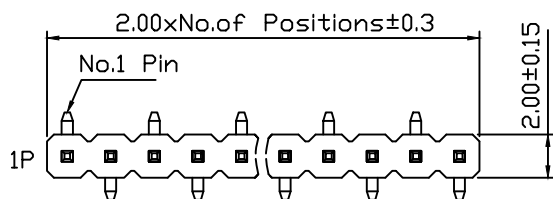
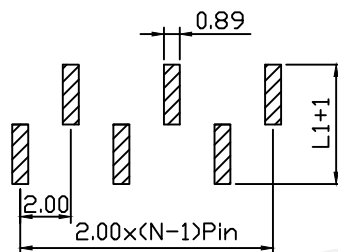

T1 Type

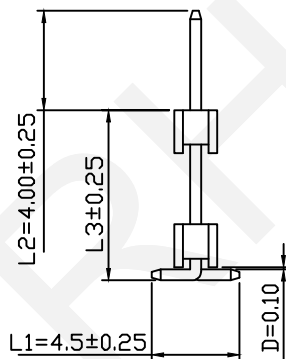
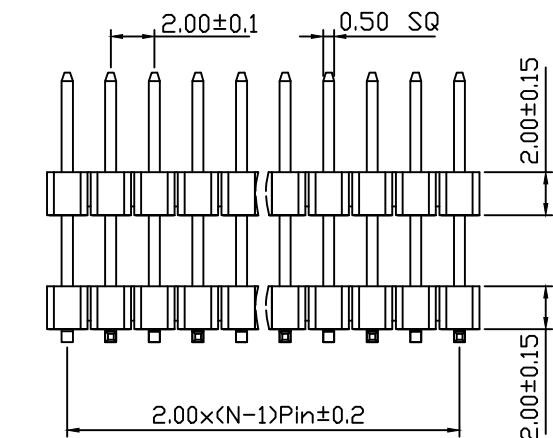
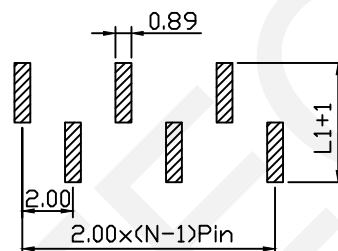

Dimension Antitheses List (mm)					
ITEM	L1	L2	L3	D	Plastic Height
Standard	4.50	4.00	---	0.10	2.00
Nonstandard	---	---	---	---	---

Material:
Standard: PA6T
Contact: Brass
Insulator: Polyester,UL94V-0
Electrical Characteristics:
Rated Current: 1.5AMP
Contact Resistance: 20mΩ Max
Withstand Voltage: 500V AC/DC
Insulator Resistance: 1000MΩ Min
Mechanical
Operating Temperature: -40°C~+105°C
Max.Processing Temp:240°C for 30-60 seconds
(260°C for 10 seconds)

Order Information:

RHTAY18B-2.00-1-XX-T1-L1xL2xL3xD-G0-N-R

Pin Header Series

18B: 2.00mm

Plastics Height:

2.00, 1.50 mm

Per Row:Single Layer

Pin: No. of Pins (1x40)

SMT Pin:T1 Type, T2 Type

Size:L1xL2xL3xD

Plating:

G0=Gold Flash G1=1u" Gold G10=10u" Gold

G15=15u" Gold G30=30u" Gold

Post:W=With Post N=W/0 Post

Packing:

0=PE Bag A=Tray T=Tube

P=Tube+Cap R=Reel+Cap

RHTECP NINGBO RHT ELECTRONIC CO.,LTD

UNITS:mm	SHEET SIZE: A4	SCALE:---	DRWN BY PAN
0~3	3~18	18~50	50~120
±0.12	±0.15	±0.3	±0.5
			CHK'D BY FENG
			APPR BY ZHAN

2.00mm Pin Header
Single Layer,SMT Mounting type, 1xN Pin

THIRD ANGLE PROJECTION

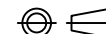

RHTAY18B-2.00-1-XX-T1-L1xL2xL3xD-G0-N-R

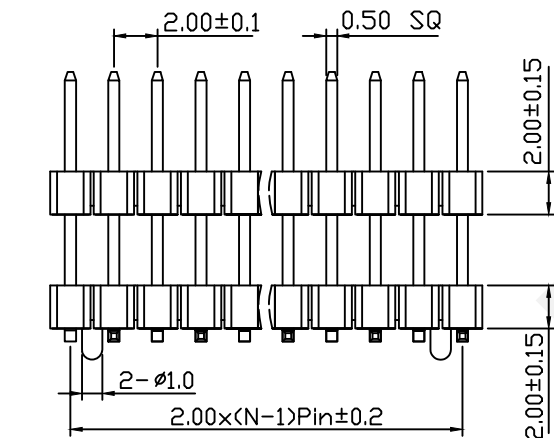
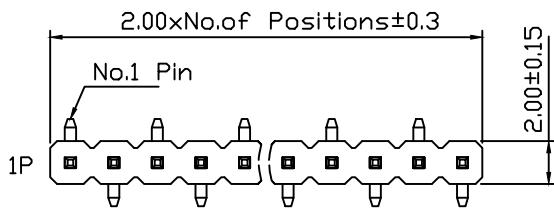
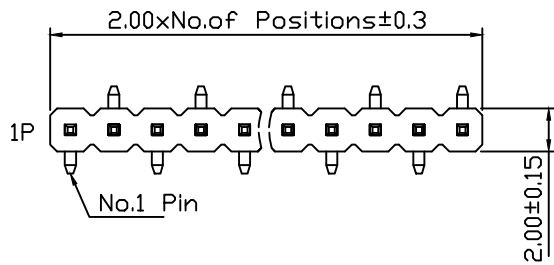

Recommended P.C.B Layout(Top Side)
(PCB BOARD TOLERANCE±0.05)

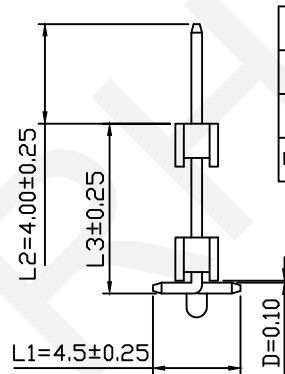
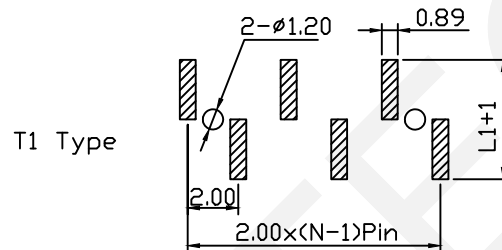
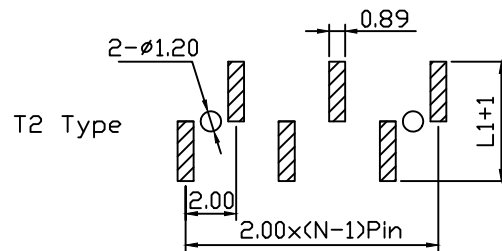

Dimension Antitheses List (mm)					
ITEM	L1	L2	L3	D	Plastic Height
Standard	4.50	4.00	---	0.10	2.00
Nonstandard	---	---	---	---	---

Material:
Standard: PA6T
Contact: Brass
Insulator: Polyester,UL94V-0
Electrical Characteristics:
Rated Current: 1.5AMP
Contact Resistance: 20mΩ Max
Withstand Voltage: 500V AC/DC
Insulator Resistance: 1000MΩ Min
Mechanical
Operating Temperature: -40°C~+105°C
Max.Processing Temp:240°C for 30-60 seconds
(260°C for 10 seconds)

Order Information:

RHTAY18B-2.00-1-XX-T1-L1xL2xL3xD-G0-W-R

Pin Header Series

18B: 2.00mm

Plastics Height:

2.00, 1.50 mm

Per Row:Single Layer

Pin: No. of Pins (1x40)

SMT Pin:T1 Type, T2 Type

Size:L1xL2xL3xD

Plating:

G0=Gold Flash G1=1u" Gold G10=10u" Gold

G15=15u" Gold G30=30u" Gold

Post:W=With Post N=W/0 Post

Packing:

0=PE Bag A=Tray T=Tube

P=Tube+Cap R=Reel+Cap

RHTECP NINGBO RHT ELECTRONIC CO.,LTD

UNITS:mm	SHEET SIZE: A4	SCALE:---	DRWN BY PAN
0~3	3~18	18~50	50~120
±0.12	±0.15	±0.3	±0.5
CHK'D BY FENG		APPR BY ZHAN	

2.00mm Pin Header Single Layer,SMT Mounting type, 1xN Pin	
THIRD ANGLE PROJECTION	RHTAY18B-2.00-1-XX-T1-L1xL2xL3xD-G0-W-R



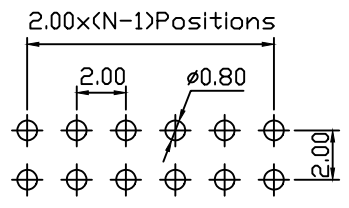
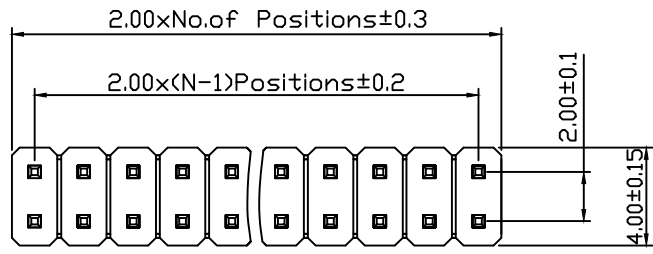

Recommend P.C.Board Layout
PCB Tolerance±0.05(Top View)

Material:
Standard: PA6T
Contact: Brass
Insulator: Polyester,UL94V-0
Electrical Characteristics:
Rated Current: 1.5AMP
Contact Resistance: 20mΩ Max
Withstand Voltage: 500V AC/DC
Insulator Resistance: 1000MΩ Min
Mechanical
Operating Temperature: -40°C~+105°C
Max.Processing Temp:240°C for 30-60 seconds
(260°C for 10 seconds)

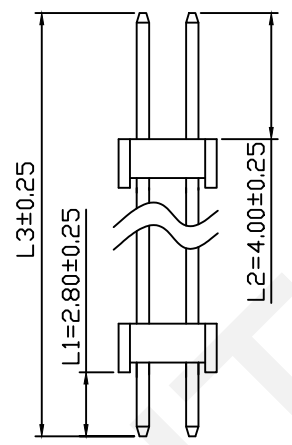
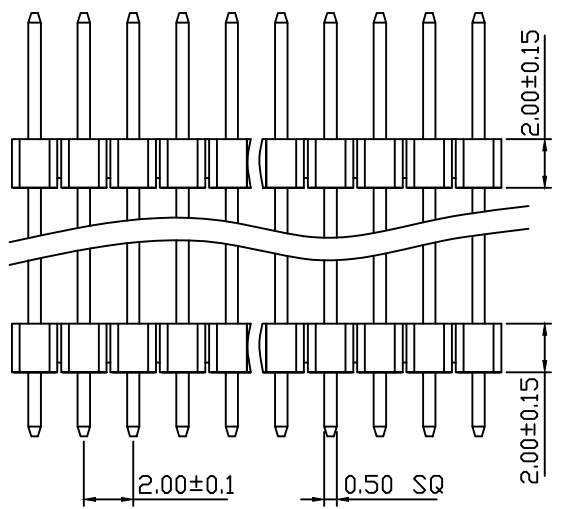

S Type

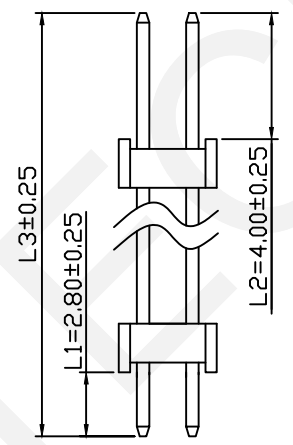

S1 Type

Order Information:
RHTAY18B-2.00-2-XX-S-L1xL2xL3-G0

Pin Header Series
18B: 2.00mm
Plastics Height: 2.00, 1.50 mm
Per Row:Double Layer
Pin: No. of Pins (02~80)
Straight Pin:S Type, S1 Type
Size:L1xL2xL3
Plating:
G0=Gold Flash G1=1u" Gold
G10=10u" Gold G15=15u" Gold
G30=30u" Gold

Dimension Antitheses List (mm)				
ITEM	L1	L2	L3	Plastic Height
Standard	2.80	4.00	---	2.00
Nonstandard	---	---	---	---

UNITS:mm	SHEET SIZE: A4		SCALE:---	DRWN BY PAN
0~3	3~18	18~50	50~120	CHK'D BY FENG
±0.12	±0.15	±0.3	±0.5	APPR BY ZHAN

2.00mm Pin Header
Double Layer, Straight Pin, 2xN Pin
THIRD ANGLE PROJECTION
RHTAY18B-2.00-2-XX-S-L1xL2xL3-G0



NINGBO RHT ELECTRONIC CO.,LTD

1 2 3 4 5 6 7 8 9

A

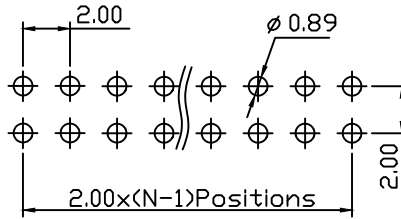
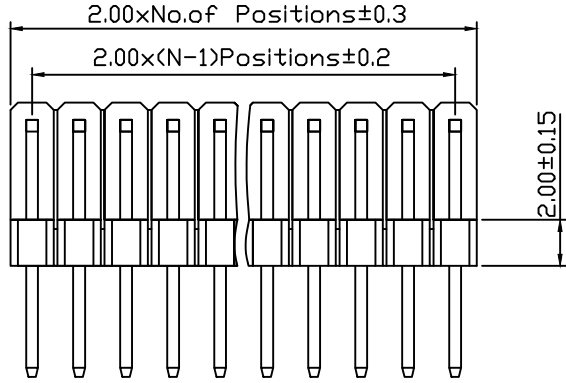

Recommend P.C.Board Layout
PCB Tolerance±0.05<Top View>

Material:
Standard: PA6T
Contact: Brass
Insulator: Polyester,UL94V-0
Electrical Characteristics:
Rated Current: 1.5AMP
Contact Resistance: 20mΩ Max
Withstand Voltage: 500V AC/DC
Insulator Resistance: 1000MΩ Min
Mechanical
Operating Temperature: -40°C~+105°C
Max.Processing Temp:240°C for 30-60 seconds
(260°C for 10 seconds)

B

C

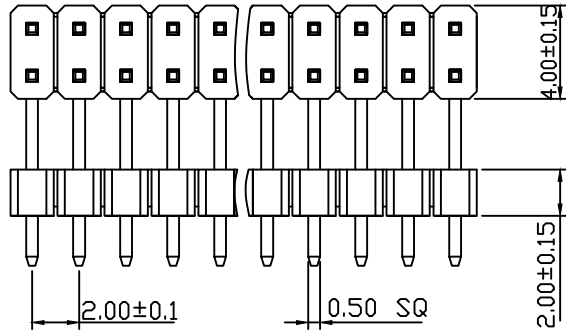

Dimension Antitheses List (mm)						
ITEM	L1	L2	D	D1	D2	Plastic Height
Standard	2.80	4.00	---	---	---	2.00
Nonstandard	---	---	---	---	---	---

Order Information:
RHTAY18B-2.00-2-XX-R2-L1xL2xD-G0

Pin Header Series
18B: 2.00mm
Plastics Height: 2.00, 1.50 mm
Per Row:Double Layer
Pin: No. of Pins (02~80)
Right Angle Pin:R1Type, R2Type
Size:L1xL2xD
Plating:
G0=Gold Flash G1=1u" Gold
G10=10u" Gold G15=15u" Gold
G30=30u" Gold

D

E

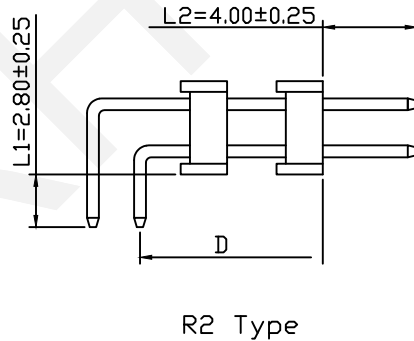
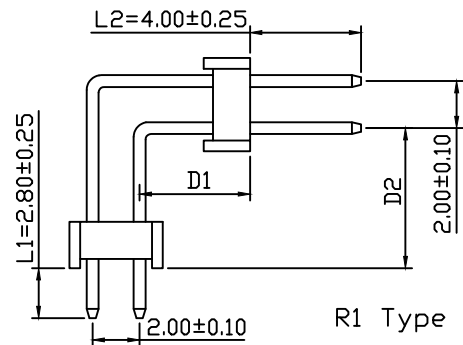

F

G

RHTECP NINGBO RHT ELECTRONIC CO.,LTD

UNITS:mm	SHEET SIZE: A4	SCALE:---	DRWN BY PAN
0~3	3~18	18~50	50~120
±0.12	±0.15	±0.3	±0.5
CHK'D BY FENG			APPR BY ZHAN

2.00mm Pin Header Double Layer,Right Angle Pin, 2xN Pin	
THIRD ANGLE PROJECTION 	RHTAY18B-2.00-2-XX-R2-L1xL2xD-G0

1 2 3 4 5 6 7 8 9

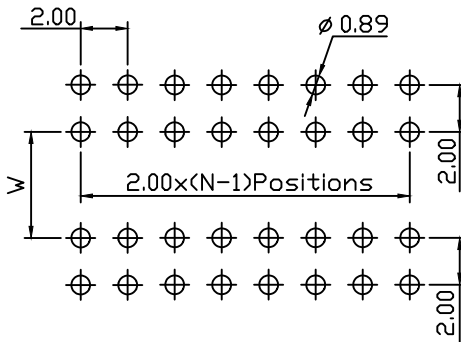
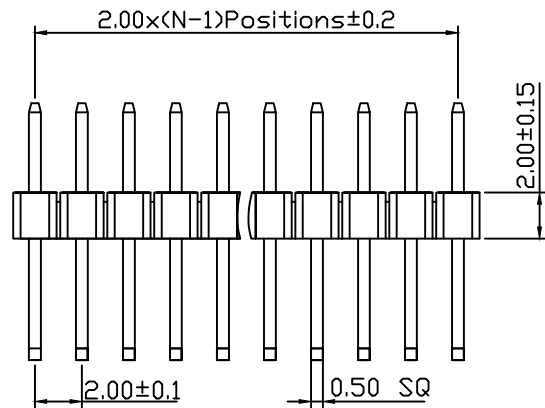

Recommend P.C.Board Layout
PCB Tolerance±0.05(Top View)

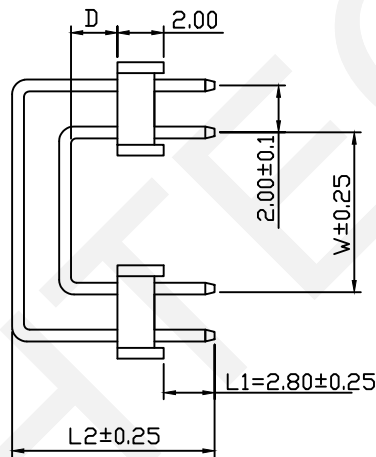
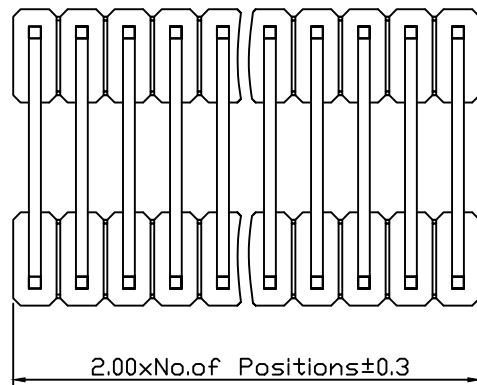

Dimension Antitheses List (mm)					
ITEM	L1	L2	D	W	Plastic Height
Standard	2.80	---	---	---	2.00
Nonstandard	---	---	---	---	---

Material:
Standard: PA6T
Contact: Brass
Insulator: Polyester,UL94V-0
Electrical Characteristics:
Rated Current: 1.5AMP
Contact Resistance: 20mΩ Max
Withstand Voltage: 500V AC/DC
Insulator Resistance: 1000MΩ Min
Mechanical
Operating Temperature: -40°C~+105°C
Max.Processing Temp:240°C for 30-60 seconds
(260°C for 10 seconds)

Order Information:
RHTAY18B-2.00-2-XX-R3-L1xL2xDxW-G0

Pin Header Series
18B: 2.00mm
Plastics Height:
2.00, 1.50 mm
Per Row:Double Layer
Pin: No. of Pins (02~80)
Type:Right Angle Pin
Size:L1xL2xDxW
Plating:
G0=Gold Flash G1=1u" Gold
G10=10u" Gold G15=15u" Gold
G30=30u" Gold

RHTECP NINGBO RHT ELECTRONIC CO.,LTD

UNITS:mm SHEET SIZE: A4 SCALE:--- DRWN BY PAN
0~3 3~18 18~50 50~120 CHK'D BY FENG
±0.12 ±0.15 ±0.3 ±0.5 APPR BY ZHAN

2.00mm Pin Header
Double Layer,Right Angle Pin, 2xN Pin
THIRD ANGLE PROJECTION
RHTAY18B-2.00-2-XX-R3-L1xL2xDxW-G0

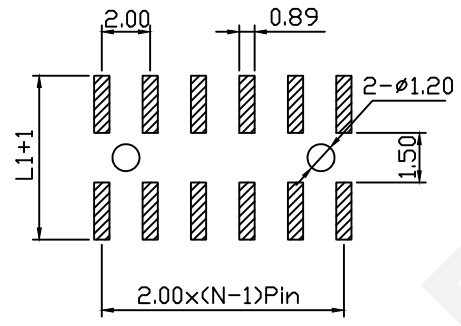
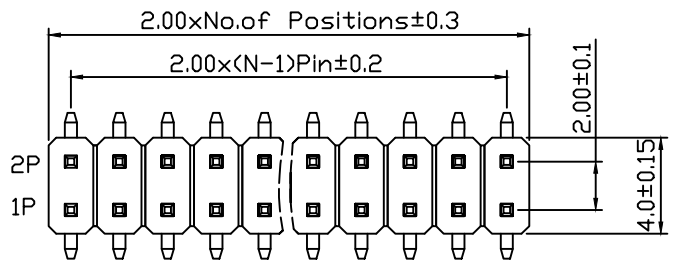

Material:
 Standard: PA6T
 Contact: Brass
 Insulator: Polyester,UL94V-0
 Electrical Characteristics:
 Rated Current: 1.5AMP
 Contact Resistance: 20mΩ Max
 Withstand Voltage: 500V AC/DC
 Insulator Resistance: 1000MΩ Min
 Mechanical
 Operating Temperature: -40°C~+105°C
 Max.Processing Temp:240°C for 30-60 seconds
 (260°C for 10 seconds)

Recommended P.C.B Layout(Top Side)
 (PCB BOARD TOLERANCE±0.05)

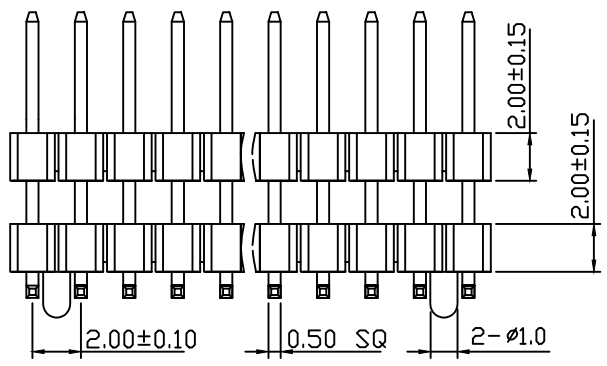

Dimension Antitheses List (mm)					
ITEM	L1	L2	L3	D	Plastic Height
Standard	6.50	4.00	---	0.10	2.00
Nonstandard	---	---	---	---	---

Order Information:
 RHTAY18B-2.00-2-XX-T-L1xL2xL3xD-G0-W-R

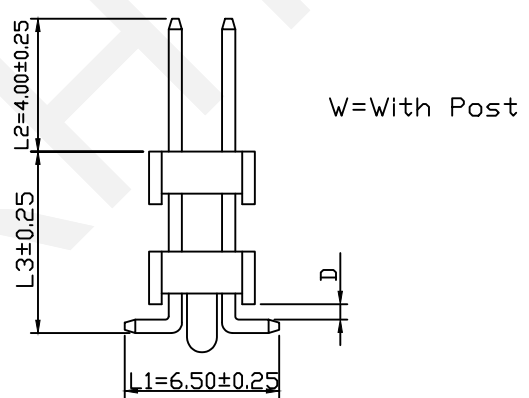
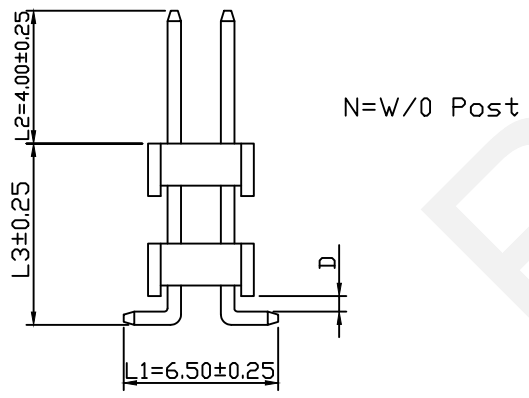
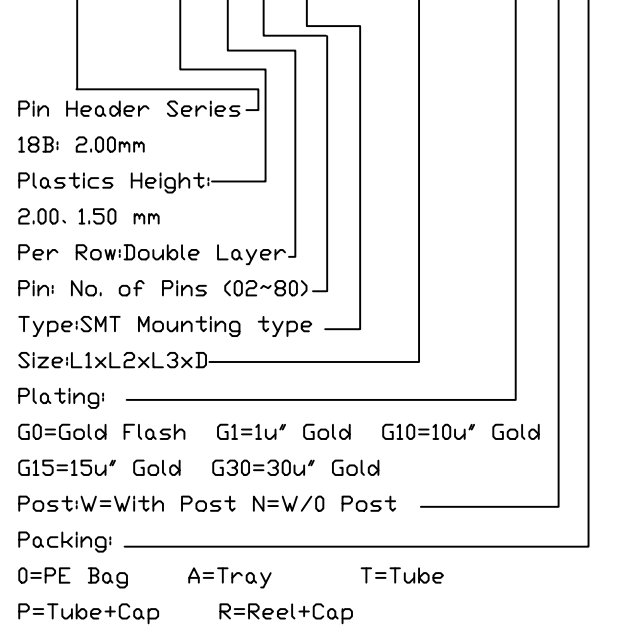

NINGBO RHT ELECTRONIC CO.,LTD

UNITS:mm	SHEET SIZE: A4			SCALE:---	DRWN BY PAN
0~3	3~18	18~50	50~120	CHK'D BY FENG	
±0.12	±0.15	±0.3	±0.5	APPR BY ZHAN	

2.00mm Pin Header
 Double Layer,SMT Mounting type, 2xN Pin
 THIRD ANGLE PROJECTION
 RHTAY18B-2.00-2-XX-T-L1xL2xL3xD-G0-W-R