

RoHS Compliance

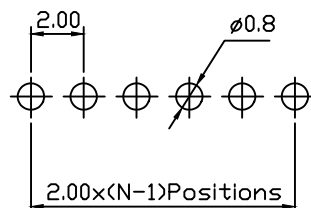

Recommended P.C.B Hole Layout

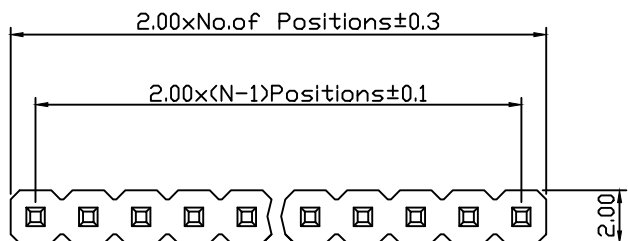
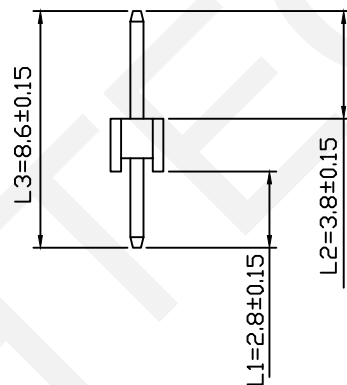
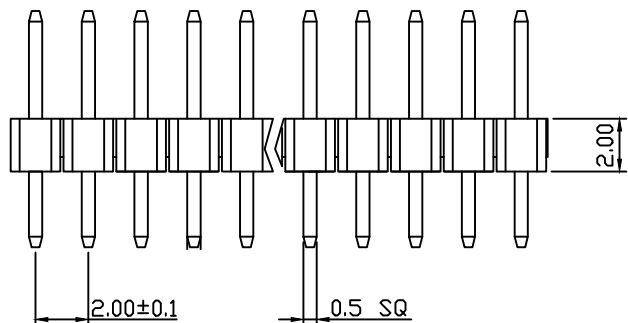

Dimension Antitheses List (mm)				
ITEM	L1	L2	L3	Plastic Height
Standard	2.80	3.80	8.60	2.00
Nonstandard	---	---	---	---

Material:  
 Standard: PA6T  
 Contact: Brass  
 Insulator: Polyester,UL94V-0  
 Electrical Characteristics:  
 Rated Current: 1.5AMP  
 Contact Resistance: 20mΩ Max  
 Withstand Voltage: 500V AC/DC  
 Insulator Resistance: 1000MΩ Min  
 Mechanical  
 Operating Temperature: -40°C~+105°C  
 Max.Processing Temp:240°C For30-60 Seconds(260°C For 10 Seconds)

Order Information:  
 RHTAY07B-2.00-1-XX-S-L1xL2xL3-G0

Pin Header Series  
 07B:2.00mm  
 Plastics Height: 1.50,2.00mm  
 Per Row:Single Layer  
 Pin: No. Of Pins (1x40)  
 Type: Straight Pin.  
 Size:L1xL2xL3  
 Plating:  
 G0=Gold Flash G1=1u" Gold  
 G10=10u" Gold G15=15u" Gold  
 G30=30u" Gold

**RHTECP** NINGBO RHT ELECTRONIC CO.,LTD

UNITS:mm	SHEET SIZE: A4		SCALE:---	DRWN BY PAN
0~3	3~18	18~50	50~120	CHK'D BY FENG
±0.12	±0.15	±0.3	±0.5	APPR BY ZHAN

2.00mm Pin Header  
 Single Layer, Straight Pin, 1xN Pin  
 THIRD ANGLE PROJECTION  
  
 RHTAY07B-2.00-1-XX-S-L1xL2xL3-G0

RoHS Compliance

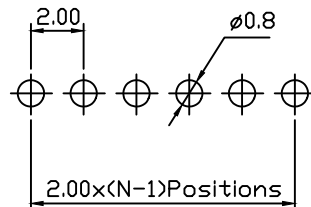
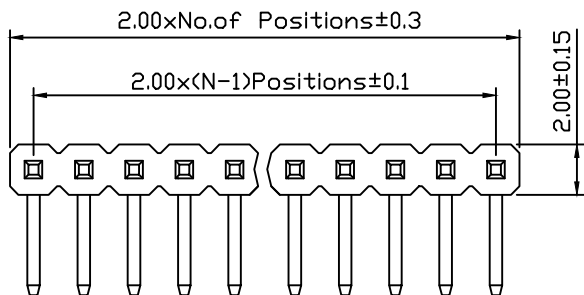

Recommended P.C.B Hole Layout

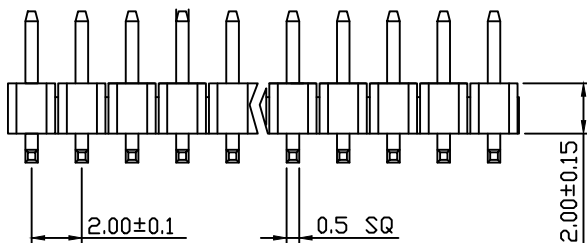

Dimension Antitheses List (mm)				
ITEM	L1	L2	L3	Plastic Height
Standard R1	2.80	3.80	1.00	2.00
Standard R2	2.80	3.80	1.00	2.00
Nonstandard	---	---	---	---

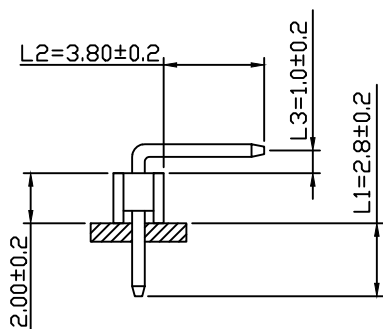

R1 Type

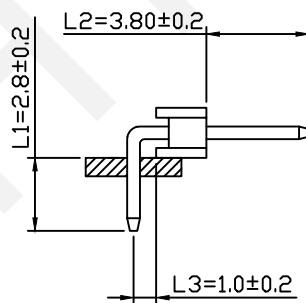

R2 Type

Material:

Standard: PBT

Contact: Phosphor Bronze

Insulator: Polyester,UL94V-0

Electrical Characteristics:

Rated Current: 15AMP

Contact Resistance: 20mΩ Max

Withstand Voltage: 500V AC/DC

Insulator Resistance: 1000MΩ Min

Mechanical

Operating Temperature: -40°C~+105°C

Order Information:

RHTAY07B-2.00-1-XX-R1-L1xL2xL3-G0

Pin Header Series

07B:2.00mm

Plastics Height:

1.50,2.00mm

Per Row:Single Layer

Pin: No. Of Pins (1x40)

Right Angle Pin:R1 Type,R2 Type

Size:L1xL2xL3

Plating:

G0=Gold Flash G1=1u' Gold

G10=10u' Gold G15=15u' Gold

G30=30u' Gold



NINGBO RHT ELECTRONIC CO.,LTD

UNITS:mm

SHEET SIZE: A4

SCALE:---

DRWN BY PAN

0~3

3~18

18~50

50~120

CHK'D BY FENG

±0.12

±0.15

±0.3

±0.5

APPR BY ZHAN

THIRD ANGLE PROJECTION

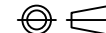

2.00mm Pin Header  
Single Layer,Right Angle Pin, 1xN Pin

RHTAY07B-2.00-1-XX-R1-L1xL2xL3-G0

RoHS Compliance

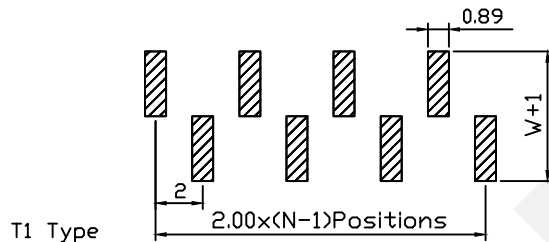
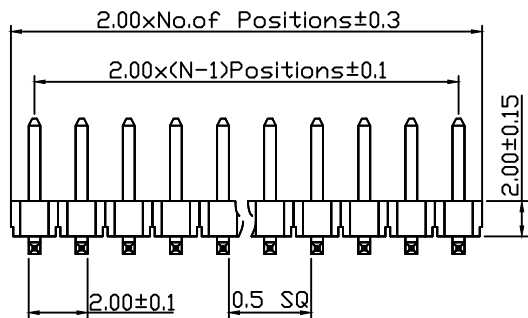
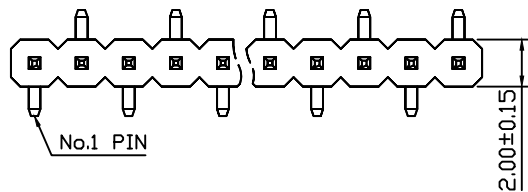
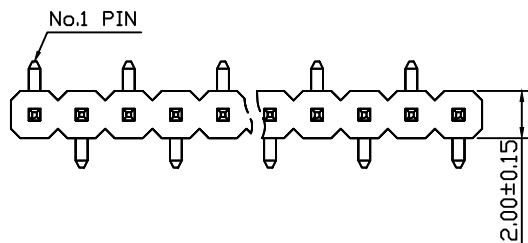

T1 Type

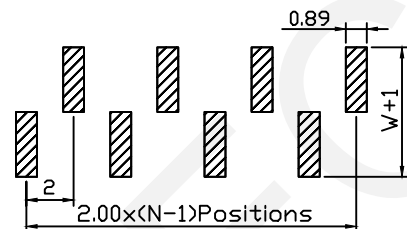

T2 Type

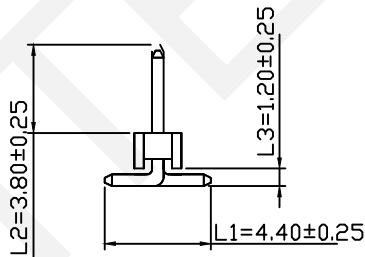

Dimension Antitheses List (mm)				
ITEM	L1	L2	L3	Plastic Height
Standard	4.00	3.80	1.20	2.00
Nonstandard	---	---	---	---

Material:  
 Standard: PA6T  
 Contact: Brass  
 Insulator: Polyester,UL94V-0  
 Electrical Characteristics:  
 Rated Current: 1.5AMP  
 Contact Resistance: 20mΩ Max  
 Withstand Voltage: 500V AC/DC  
 Insulator Resistance: 1000MΩ Min  
 Mechanical  
 Operating Temperature: -40°C~+105°C  
 Max.Processing Temp:230°C For30-60  
 Seconds(260°C For10 Seconds)

Order Information:

RHTAY07B-2.00-1-XX-T1-L1xL2xL3-G0-N-R

Pin Header Series  
 07B:2.00mm  
 Plastics Height:  
 1.50,2.00mm  
 Per Row:Single Layer  
 Pin: No. Of Pins (1x40)  
 SMT Pin:T1 Type,T2 Type  
 Size:L1xL2xL3  
 Plating:  
 G0=Gold Flash G1=1u' Gold G10=10u'  
 Gold G15=15u' Gold G30=30u' Gold  
 Post:W=With PostN=W/0 Post  
 Packing:  
 0=PE Bag A=Tray T=Tube  
 P=Tube+Cap R=Reel+Cap

**RHTECP** NINGBO RHT ELECTRONIC CO.,LTD

UNITS:mm SHEET SIZE: A4 SCALE:---  
 0~3 3~18 18~50 50~120  
 ±0.12 ±0.15 ±0.3 ±0.5

DRWN BY PAN  
 CHK'D BY FENG  
 APPR BY ZHAN

2.00mm Pin Header Single Layer,SMT,1xN Pin  
 THIRD ANGLE PROJECTION  
 RHTAY07B-2.00-1-XX-T1-L1xL2xL3-G0-N-R

RoHS Compliance

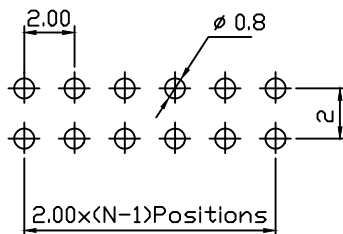
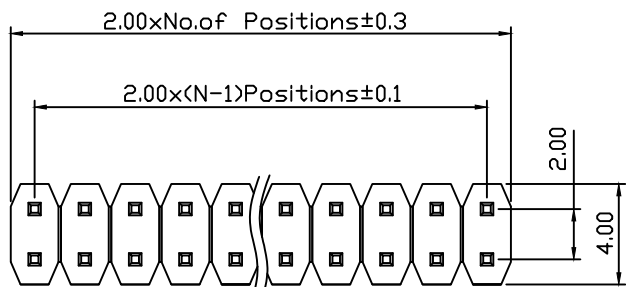

Recommended P.C.B Hole Layout

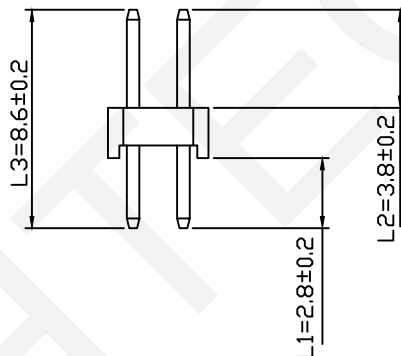
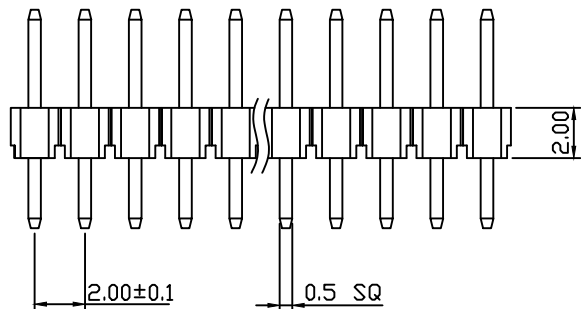

Dimension Antitheses List (mm)				
ITEM	L1	L2	L3	Plastic Height
Standard	2.80	3.80	8.60	2.00
Nonstandard	---	---	---	---

Material:  
 Standard: PA6T  
 Contact: Brass  
 Insulator: Polyester,UL94V-0  
 Electrical Characteristics:  
 Rated Current: 1.5AMP  
 Contact Resistance: 20mΩ Max  
 Withstand Voltage: 500V AC/DC  
 Insulator Resistance: 1000MΩ Min  
 Mechanical  
 Operating Temperature: -40°C~+105°C  
 Max.Processing Temp:240°C For30-60 Seconds(260°C For10 Seconds)

Order Information:  
 RHTAY07B-2.00-2-XX-S-L1xL2xL3-G0

Pin Header Series  
 07B:2.00mm  
 Plastics Height: 1.50,2.00  
 Per Row:Double Layer  
 Pin: No. Of Pins (02~80)  
 Type: Straight Pin.  
 Size:L1xL2xL3  
 Plating:  
 G0=Gold Flash G1=1u" Gold  
 G10=10u" Gold G15=15u" Gold  
 G30=30u" Gold

**RHTECP** NINGBO RHT ELECTRONIC CO.,LTD

UNITS:mm	SHEET SIZE: A4	SCALE:---	DRWN BY PAN
0~3	3~18	18~50	50~120
±0.12	±0.15	±0.3	±0.5
CHK'D BY FENG		APPR BY ZHAN	

2.00mm Pin Header  
 Double Layer, Straight Pin, 2xN Pin  
 THIRD ANGLE PROJECTION  
 RHTAY07B-2.00-2-XX-S-L1xL2xL3-G0

RoHS Compliance

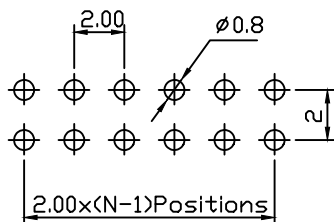
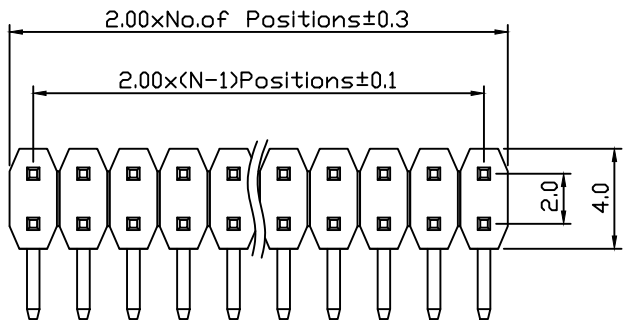

Recommended P.C.B Hole Layout

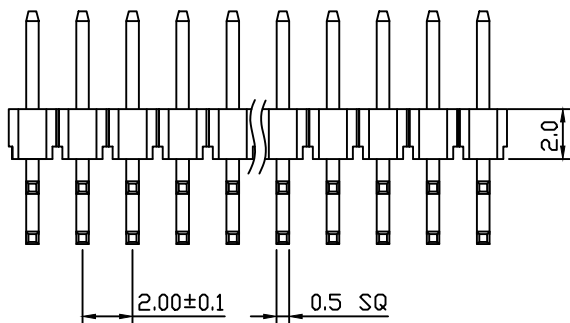

Dimension Antitheses List (mm)				
ITEM	L1	L2	L3	Plastic Height
Standard	2.80	3.80	1.00	2.00
Nonstandard	---	---	---	---

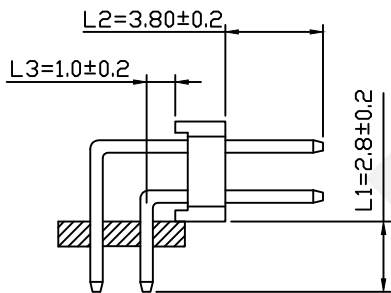

R1 Type

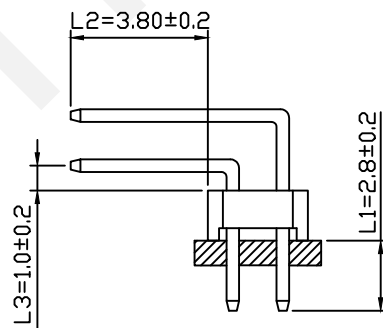

Material:  
 Standard: PBT  
 Contact: Phosphor Bronze  
 Insulator: Polyester,UL94V-0  
 Electrical Characteristics:  
 Rated Current: 1.5AMP  
 Contact Resistance: 20mΩ Max  
 Withstand Voltage: 500V AC/DC  
 Insulator Resistance: 1000MΩ Min  
 Mechanical  
 Operating Temperature: -40°C~+105°C

Order Information:  
 RHTAY07B-2.00-2-XX-R1-L1xL2xL3-G0

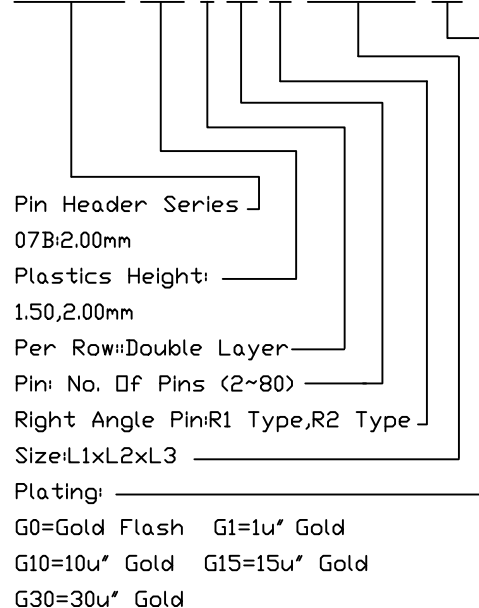

NINGBO RHT ELECTRONIC CO.,LTD

UNITS:mm	SHEET SIZE: A4	SCALE:---	DRWN BY PAN
0~3	3~18	18~50	50~120
±0.12	±0.15	±0.3	±0.5
			CHK'D BY FENG
			APPR BY ZHAN

2.00mm Pin Header  
 Double Layer,Right Angle Pin, 2xN Pin

THIRD ANGLE PROJECTION

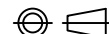

RHTAY07B-2.00-2-XX-R1-L1xL2xL3-G0

RoHS Compliance

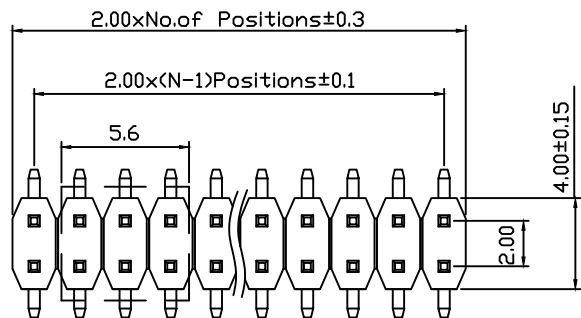

Recommended P.C.B Hole Layout

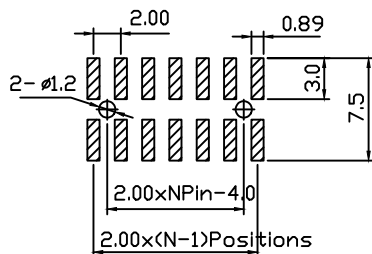

Material:  
 Standard: PA6T  
 Contact: Brass  
 Insulator: Polyester,UL94V-0  
 Electrical Characteristics:  
 Rated Current: 1.5AMP  
 Contact Resistance: 20mΩ Max  
 Withstand Voltage: 500V AC/DC  
 Insulator Resistance: 1000MΩ Min  
 Mechanical  
 Operating Temperature: -40°C~+105°C  
 Max.Processing Temp:240°C For30-60 Seconds(260°C For10 Seconds)

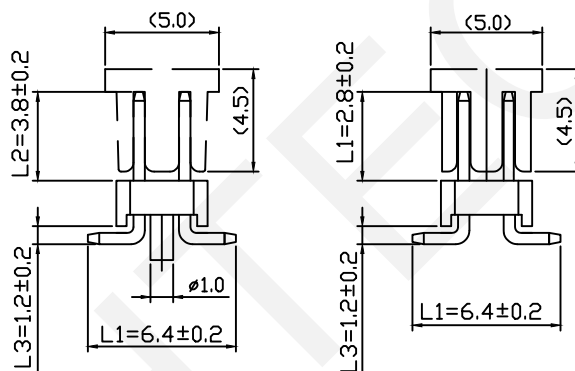
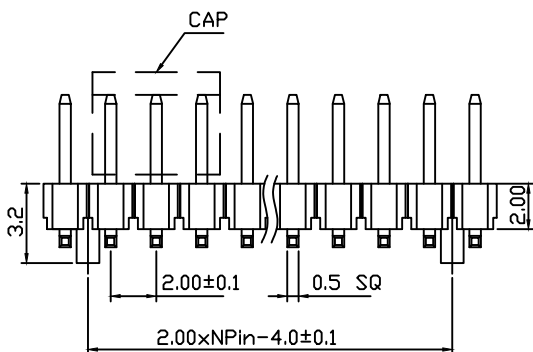

T3=With Post

T=W/D Post

Dimension Antitheses List (mm)				
ITEM	L1	L2	L3	Plastic Height
Standard	6.40	3.80	1.20	2.00
Nonstandard	---	---	---	---

Order Information:

RHTAY07B-2.00-2-XX-T-L1xL2xL3-G0-R

Pin Header Series  
 07B:2.00mm  
 Plastics Height: \_\_\_\_\_  
 1.50,2.00mm  
 Per Row: Dual Row \_\_\_\_\_  
 Pin: No. Of Pins (2~80) \_\_\_\_\_  
 Post: T3=With Post T=W/D Post, \_\_\_\_\_  
 Size: L1xL2xL3 \_\_\_\_\_  
 Plating: \_\_\_\_\_  
 G0=Gold Flash G1=1u' Gold G10=10u'  
 Gold G15=15u' Gold G30=30u' Gold  
 Packing: \_\_\_\_\_  
 0=PE Bag A=Tray T=Tube  
 P=Tube+Cap R=Reel+Cap

NINGBO RHT ELECTRONIC CO.,LTD

UNITS:mm SHEET SIZE: A4 SCALE:--- DRWN BY PAN  
 0~3 3~18 18~50 50~120 CHK'D BY FENG  
 ±0.12 ±0.15 ±0.3 ±0.5 APPR BY ZHAN

2.00mm Pin Header Dual Row,SMT,2xN Pin

THIRD ANGLE PROJECTION

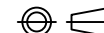

RHTAY07B-2.00-2-XX-T-L1xL2xL3-G0-R