

PCB Layout

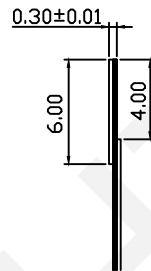

Proper Cable

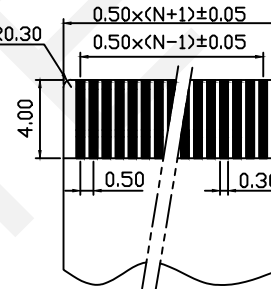

Material

Housing:LCP UL94V-0

Terminal:Phosphor Bronze Tin-plated

Fitting Nial:Phosphor Bronze Tin-plated

Electrical

Voltage Rating: 50 V

Current Rating: 0.4 A

Withstanding Voltage:200 V

Insulation Resistance: 500MΩ.Min.

Contact Resistance: 20mΩ.Max.

Mechanical

Temp Range:-25℃~+85℃

Order Information

RHTAY242-2.0-XX-T-U-R

Series No.]

Height:2.0mm]

No.of Pins]

(06~60 Pins)

T-SMT Pin]

U-Upper Contact]

Pack: T-Tube R-Reel]



NINGBO RHT ELECTRONIC CO.,LTD

UNITS:mm

SHEET SIZE: A4

SCALE:---

DRWN BY PAN

0~3

3~18

18~50

50~120

CHK'D BY FENG

±0.12

±0.15

±0.3

±0.5

APPR BY ZHAN

THIRD ANGLE PROJECTION

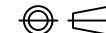

CONN FFC 0.50mm,SMD,
Horizontal, Upper Contact ,With ZIF

RHTAY242-2.0-XX-T-U-R

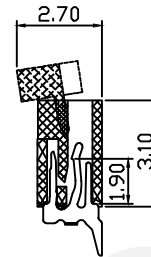
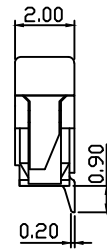
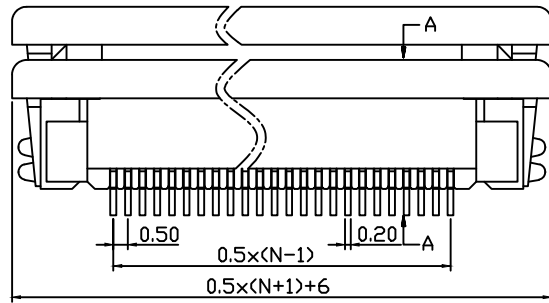

A-A

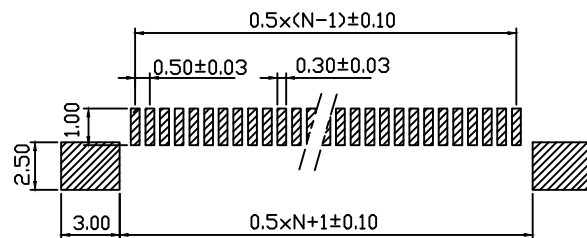

PCB Layout

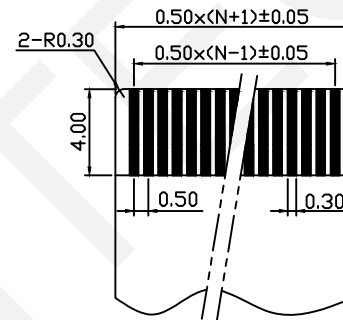
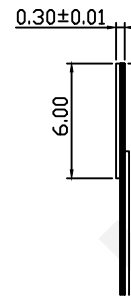

Proper Cable

Material

Housing:LCP UL94V-0

Terminal:Phosphor Bronze Tin-plated

Fitting Nial:Phosphor Bronze Tin-plated

Electrical

Voltage Rating: 50 V

Current Rating: 0.4 A

Withstanding Voltage:200 V

Insulation Resistance: 500MΩ.Min.

Contact Resistance: 20mΩ.Max.

Mechanical

Temp Range:-25℃~+85℃

Order Information

RHTAY242-2.0-XX-T-L-R

Series No.]

Height:2.0mm]

No.of Pins

(04~60 Pins)

T-SMT Pin

L-Lower Contact

Pack: T-Tube R-Reel

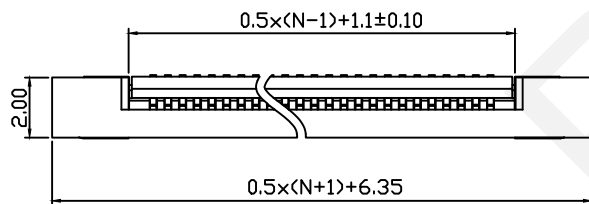

UNITS:mm	SHEET SIZE: A4			SCALE:---	DRWN BY PAN
0~3	3~18	18~50	50~120	CHK'D BY FENG	
±0.12	±0.15	±0.3	±0.5	APPR BY ZHAN	

CONN FFC 0.50mm,SMD, Horizontal, Lower Contact ,With ZIF	
THIRD ANGLE PROJECTION	RHTAY242-2.0-XX-T-L-R

