

RoHS Compliance

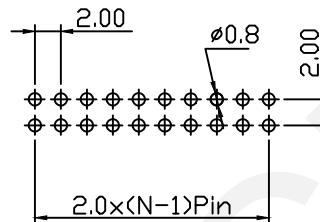
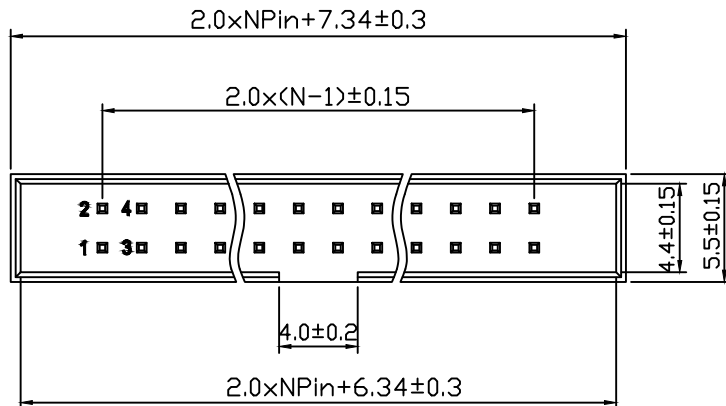

Recommended P.C.B Layout(Top Side)  
(PCB BOARD TOLERANCE±0.05)

Material:  
Housing: PA6T, UL94V-0  
Contact: Brass  
Plating: Gold Plated

Electrical Characteristics:  
Rated Current: 1.5AMP  
Contact Resistance: 20MΩ Max  
Withstand Voltage: 400V AC/DC  
Insulator Resistance: 800MΩ Min

Mechanical  
Operating Temperature: -40°C~+105°C  
Max.Processing Temp: 230°C For 30-60  
Seconds (260°C For 10 Seconds)

Order Information:

RHTAY02B-XX-S-B-□

Box Header Series  
02B: 2.00mm Pitch  
XX-No.of 06~64 pins  
Type:S-Straight pin  
R-Right Angle Pin T-SMT  
Color:B-Black G-Gray  
Material: NONE=PA6T  
A=PBT C=LCP

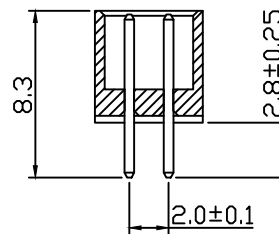
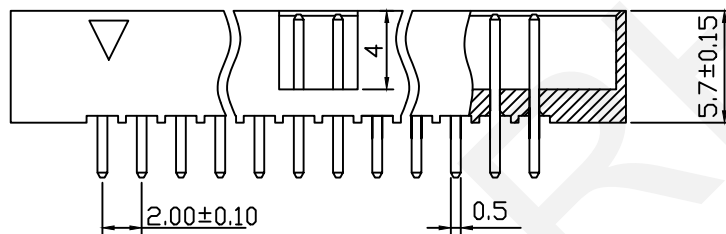

**RHTECP** NINGBO RHT ELECTRONIC CO.,LTD

UNITS:mm	SHEET SIZE: A4	SCALE:---	DRWN BY PAN
0~3	3~18	18~50	50~120
±0.12	±0.15	±0.3	±0.5
CHK'D BY FENG		APPR BY ZHAN	

2.00mm Pitch Box Header Connector  
THIRD ANGLE PROJECTION  
RHTAY02B-XX-S-B-□

RoHS Compliance

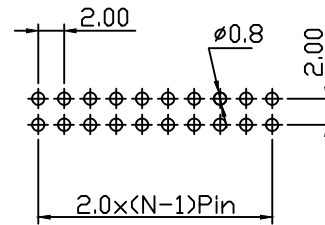
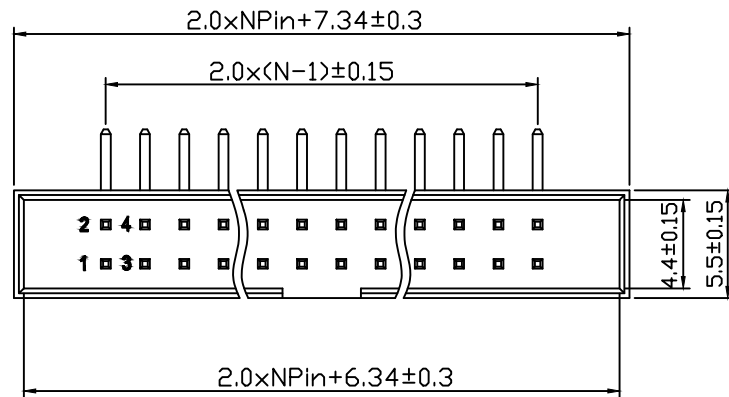

Recommended P.C.B Layout(Top Side)  
(PCB BOARD TOLERANCE±0.05)

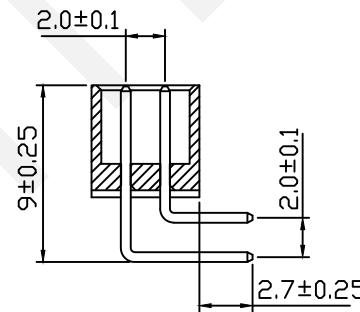
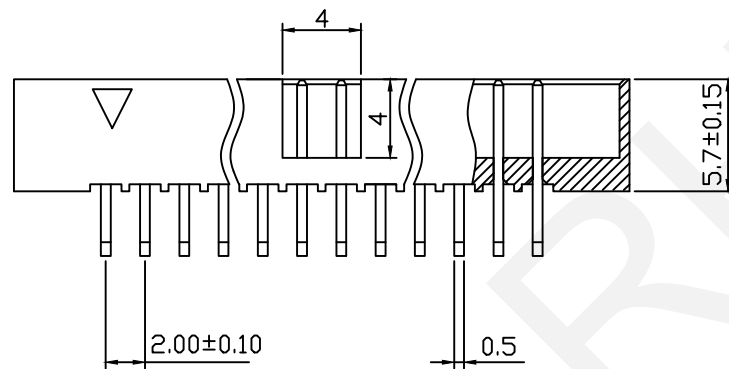

Material:

Housing: PA6T, UL94V-0

Contact: Brass

Plating: Gold Plated

Electrical Characteristics:

Rated Current: 1.5AMP

Contact Resistance: 20MΩ Max

Withstand Voltage: 400V AC/DC

Insulator Resistance: 800MΩ Min

Mechanical

Operating Temperature:-40°C~+105°C

Max.Processing Temp:230°C For 30-60

Seconds (260°C For 10 Seconds)

Order Information:

RHTAY02B-XX-R-B-□

Box Header Series

02B: 2.00mm Pitch

XX-No.of 06~64 pins

Type:S-Straight pin

R-Right Angle Pin T-SMT

Color:B-Black G-Gray

Material:NONE=PA6T

A=PBT C=LCP

**RHTECP** NINGBO RHT ELECTRONIC CO.,LTD

UNITS:mm	SHEET SIZE: A4	SCALE:---	DRWN BY PAN
0~3	3~18	18~50	50~120
±0.12	±0.15	±0.3	±0.5

CHK'D BY FENG  
APPR BY ZHAN

2.00mm Pitch Box Header Connector  
THIRD ANGLE PROJECTION  
RHTAY02B-XX-R-B-□

RoHS Compliance

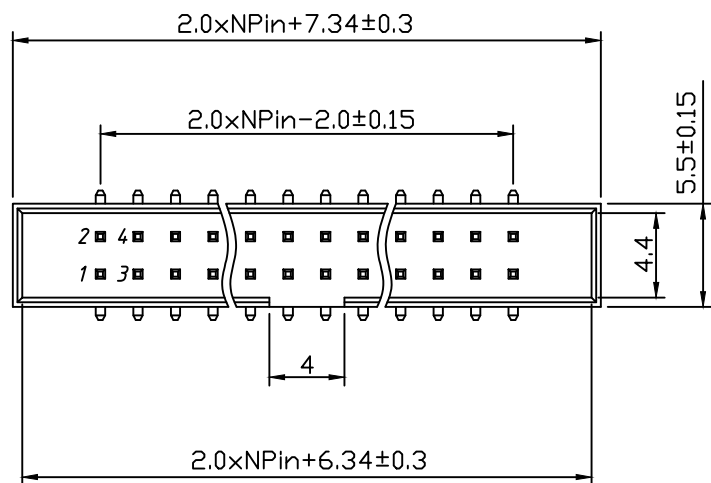

Recommended P.C.B Layout(Top Side)  
(PCB BOARD TOLERANCE±0.05)

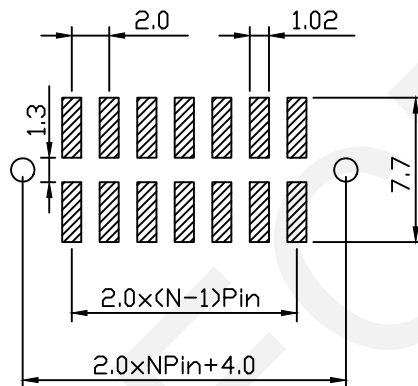

Material:  
Housing: PA6T, UL94V-0  
Contact: Brass  
Plating: Gold Plated

Electrical Characteristics:  
Rated Current: 1.5AMP  
Contact Resistance: 20MΩ Max  
Withstand Voltage: 400V AC/DC  
Insulator Resistance: 800MΩ Min

Mechanical  
Operating Temperature: -40°C~+105°C  
Max.Processing Temp: 230°C For 30-60  
Seconds (260°C For 10 Seconds)

Order Information:

RHTAY02B-XX-T-B-□-T

Box Header Series  
02B: 2.00mm Pitch  
XX-No.of 06~64 pins  
SMT:T=Without Post  
T3=With Post  
Color:B-Black G-Gray  
Material: NONE=PA6T  
A=PBT C=LCP  
Packing:  
T=Tube P=Tube+Cap R=Reel+Cap

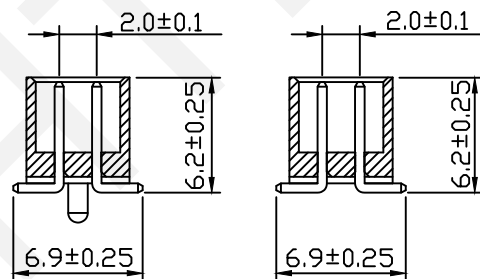
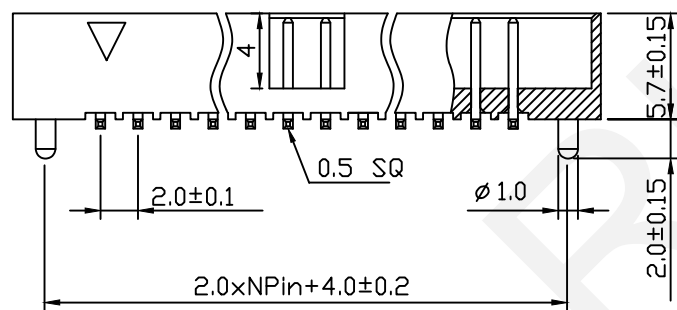

T3=With Post T=Without Post

UNITS:mm	SHEET SIZE: A4				SCALE:---	DRWN BY PAN
0~3	3~18	18~50	50~120	CHK'D BY FENG	2.00mm Pitch Box Header Connector	
±0.12	±0.15	±0.3	±0.5	APPR BY ZHAN	THIRD ANGLE PROJECTION	RHTAY02B-XX-T-B-□-T

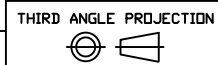

NINGBO RHT ELECTRONIC CO.,LTD